

**LAS VIRGENES - TRIUNFO  
JOINT POWERS AUTHORITY  
AGENDA**

**4232 Las Virgenes Road, Calabasas, CA 91302**

**December 7, 2020, 5:00 PM**

Public Participation for Meetings of Las Virgenes - Triunfo Joint Powers Authority in Response to COVID-19

On March 4, 2020, Governor Newsom proclaimed a State of Emergency in California as a result of the threat of COVID-19. On March 17, 2020, Governor Newsom issued Executive Order N-29-20 (superseding the Brown Act-related provisions of Executive Order N-25-20 issued on March 12, 2020), which allows a local legislative body to hold public meetings via teleconferencing and to make public meetings accessible telephonically or otherwise electronically to all members of the public seeking to observe and to address the local legislative body. Pursuant to Executive Order N-29-20, please be advised that members of the Las Virgenes - Triunfo Joint Powers Authority will participate in meetings telephonically.

**PUBLIC PARTICIPATION:** Pursuant to Executive N-29-20 and given the current health concerns, members of the public can access meetings live on-line, with audio and limited video, at [www.LVMWD.com/JPALiveStream](http://www.LVMWD.com/JPALiveStream). In addition, members of the public can submit comments electronically for consideration by sending them to [www.LVMWD.com/JPALiveStream](http://www.LVMWD.com/JPALiveStream). To ensure distribution to the members of the Las Virgenes - Triunfo Joint Powers Authority prior to consideration of the agenda, please submit comments 24 hours prior to the day of the meeting. Those comments, as well as any comments received after 5:00 P.M., will be distributed to the members of the Board of Directors and will be made part of the official public record of the meeting. Contact Josie Guzman, Executive Assistant/Clerk of the Board at (818) 251-2123 or [jguzman@lvmwd.com](mailto:jguzman@lvmwd.com) with any questions.

**ACCESSIBILITY:** If requested, the agenda and backup materials will be made available in appropriate alternative formats to persons with a disability, as required by Section 202 of the Americans with Disabilities Act of 1990 (42 U.S.C. Sec. 12132), and the federal rules and regulations adopted in implementation thereof. Any person who requires a disability-related modification or accommodation, in order to observe and/or offer public comment may request such reasonable modification, accommodation, aid, or service by contacting the Executive Assistant/Clerk of the Board by telephone at (818) 251-2123 or via email to [jguzman@lvmwd.com](mailto:jguzman@lvmwd.com) no later than 8:00 AM on the day of the scheduled meeting.

Members of the public wishing to address the Las Virgenes-Triunfo Joint Powers Authority (JPA) Board of Directors are advised that a statement of Public Comment Protocols is available from the Clerk of the Board. Prior to speaking, each speaker is asked to review these protocols, complete a speakers' card, and hand it to the Clerk of the Board. Speakers will be recognized in the order the cards are received.

The Public Comments agenda item is presented to allow the public to address the Board on matters not on the agenda. The public may also present comments on matters on the agenda; speakers for agendized items will be recognized at the time the item is called up for discussion.

Materials prepared by the JPA in connection with the subject matter on the agenda are available for public inspection at 4232 Las Virgenes Road, Calabasas, CA 91302. Materials prepared by the JPA and distributed to the Board during this meeting are available for public inspection at the meeting or as soon thereafter as possible. Materials presented to the Board by the public will be maintained as part of the records of these proceedings and are available upon request to the Clerk of the Board.

---

## **PLEDGE OF ALLEGIANCE**

### **1 CALL TO ORDER AND ROLL CALL**

### **2 APPROVAL OF AGENDA**

### **3 PUBLIC COMMENTS**

Members of the public may now address the Board of Directors **ON MATTERS NOT APPEARING ON THE AGENDA**, but within the jurisdiction of the Board. No action shall be taken on any matter not appearing on the agenda unless authorized by Subdivision (b) of Government Code Section 54954.2

### **4 CONSENT CALENDAR**

Matters listed under the Consent Calendar are considered to be routine, non-controversial and normally approved with one motion. If discussion is requested by a member of the Board on any Consent Calendar item, or if a member of the public wishes to comment on an item, that item will be removed from the Consent Calendar for separate action.

#### **A Minutes: Regular Meeting of November 2, 2020 (Pg. 4)**

Approve.

### **5 ILLUSTRATIVE AND/OR VERBAL PRESENTATION AGENDA ITEMS**

#### **A Project of the Year Award for Tapia Process Air Improvements Project: Presentation by Shahn Ahmad, APWA Regional Director (Pg. 11)**

#### **B Pure Water Project Las Virgenes-Triunfo: Update**

**C State and Federal Legislative Update**

**6 ACTION ITEMS**

**A Financial Review: First Quarter of Fiscal Year 2020-21 (Pg. 81)**

Receive and file the financial review for the first quarter of Fiscal Year 2020-21.

**B Carbon Tower Carbon Replacement: Authorization of Purchase Order (Pg. 88)**

Authorize the Administering Agent/General Manager to issue a purchase order to Karbonous, Inc., in the amount of \$39,876.90, for carbon tower media replacement at the Tapia Water Reclamation Facility and Lift Station Nos. 1 and 2.

**C Sewer System Management Plan: Approval and Recertification (Pg. 90)**

Approve the 2020 Sewer System Management Plan, JPA Report No. 2797.00; and authorize the Administering Agent/General Manager, or his designee, to recertify and submit the updated plan to the State Water Resources Control Board.

**D Pure Water Demonstration Project Sustainability Garden: Authorization of Change Order (Pg. 118)**

Authorize the Administering Agent/General Manager to approve Change Order No. 2 with the Urban Water Group, in the amount of \$26,850, for additional professional services to support the Pure Water Demonstration Project Sustainability Garden.

**7 BOARD COMMENTS**

**8 ADMINISTERING AGENT/GENERAL MANAGER REPORT**

**9 FUTURE AGENDA ITEMS**

**10 INFORMATION ITEMS**

**A Rancho Solar Generation Project Phase II: Estoppel Certificates (Pg. 123)**

**B Rancho Las Virgenes Composting Facility: Fire Protection for Exterior Amendment Hopper Opening (Pg. 138)**

**C Pure Water Project Las Virgenes-Triunfo: Energy Demand and Recovery for Reverse Osmosis Process (Pg. 143)**

**11 PUBLIC COMMENTS**

Members of the public may now address the Board of Directors **ON MATTERS NOT APPEARING ON THE AGENDA**, but within the jurisdiction of the Board. No action shall be taken on any matter not appearing on the agenda unless authorized by Subdivision (b) of Government Code Section 54954.2

**12 ADJOURNMENT**

Pursuant to Section 202 of the Americans with Disabilities Act of 1990 (42 U.S.C. Sec. 12132), and applicable federal rules and regulations, requests for a disability-related modification or accommodation, including auxiliary aids or services, in order to attend or participate in a meeting, should be made to the Executive Assistant/Clerk of the Board in advance of the meeting to ensure availability of the requested service or accommodation. Notices, agendas, and public documents related to the Board meetings can be made available in appropriate alternative format upon request.

**LAS VIRGENES – TRIUNFO  
JOINT POWERS AUTHORITY  
MINUTES  
REGULAR MEETING**

---

5:00 PM

November 2, 2020

**PLEDGE OF ALLEGIANCE**

The Pledge of Allegiance to the Flag was led by Leon Shapiro.

**1. CALL TO ORDER AND ROLL CALL**

The meeting was called to order at **5:00 p.m.** by Chair Lewitt via teleconference in the Board Room at Las Virgenes Municipal Water District headquarters at 4232 Las Virgenes Road, Calabasas, CA 91302. The meeting was conducted via teleconference pursuant to the provisions of the Governor’s Executive Order, N-29-20, which suspended certain requirements of the Ralph M. Brown Act to support social distancing guidelines associated with response to the coronavirus (COVID-19) outbreak. Josie Guzman, Clerk of the Board, conducted the roll call.

Present: Directors Caspary, Lewitt, Lo-Hill, Nye, Orkney, Polan, Renger, Shapiro, Tjulander, and Wall.

Absent: None.

**2. APPROVAL OF AGENDA**

Director Caspary moved to approve the agenda. Motion seconded by Director Tjulander. Motion carried unanimously by roll call vote.

**3. PUBLIC COMMENTS**

None.

**4. CONSENT CALENDAR****A Minutes: Regular Meeting of October 5, 2020: Approve**

Director Orkney moved to approve the Consent Calendar. Motion seconded by Director Lo-Hill. Motion carried unanimously by roll call vote.

**5. ILLUSTRATIVE AND/OR VERBAL PRESENTATION AGENDA ITEMS**

## **A Pure Water Project Las Virgenes-Triunfo: Update**

Joe McDermott, Director of Engineering and External Affairs, reported that the agreement was executed with Jacobs Engineering for the Owner's Advisor/Program Manager Services for the Pure Water Project Las Virgenes-Triunfo, and a kick-off meeting would be held soon.

Riki Clark, Public Affairs Associate II, reported that plans were in place for offering garden walks and water tasting; however, no in-person tours could be offered due to COVID-19 social gathering restrictions. She noted that staff was in the process of completing the indoor virtual tour video, which should be completed by early December.

Mr. McDermott responded to a question regarding the types of handouts that would be provided to tour guests by stating that tour guests could receive the standard brochure, which was also available on the website. He noted that staff was in the process of updating the brochure with new photographs.

Director Orkney stated that her concern would be to ensure that the public realize how safe the water would be for consumption and receive details on the purification process.

Chair Lewitt stated that he would prefer that no paper handouts be provided, and that the public be directed to the website for additional information.

Ms. Clark noted that all content would be available online and by email, including garden sign QR codes, brochures, outreach materials, videos, post-surveys, and pre-surveys.

## **B State and Federal Legislative Update**

Syrus Devers, state lobbyist for the JPA with Best Best & Krieger LLP (BBK), presented the state legislative report. He stated that the Association of California Water Agencies (ACWA) State Legislative Committee met and discussed proposed bills related to fire hydrant lawsuits, costs related to Proposition 218, and water theft. He also noted that the water report on reservoirs was released and strong drought patterns were trending for one-third of the state. He noted that the five top reservoirs were above 90 percent of historic capacity. He provided an update regarding negotiations with the South Coast Air Quality Management District (SCAQMD) on the proposal to change its rules dealing with exceeding emergency generator runtime limits during a Public Safety Power Shutoff (PSPS) event and testing and maintenance. He noted that the working group would meet in December, and if sufficient progress was not made in the negotiations, he would work on introducing a spot bill for a renewed legislative effort next year.

Lowry Crook, federal lobbyist for the JPA with BBK, presented the federal legislative update. He noted that the Senate would return to session on November 8th and the House of Representatives would return to session on November 16th. He stated that negotiations for a COVID-19 relief bill would not continue until after the election. He also noted that proposed appropriations bills still needed to be passed by the Senate, and a continuing resolution might need to be adopted pending the outcome of the election. He stated that BBK was cautiously optimistic regarding the passage of the Water Resources Development Act (WRDA). He noted that the House of Representatives was seeking more funds for dredging; however, the Senate did not want to include funds for this purpose because it would score under budget rules. He stated that an Executive Order was issued regarding modernizing water management and water infrastructure, which would formalize a water sub-cabinet of the various agencies focused on water management and infrastructure. He stated that the sub-cabinet would be directed to review all of the various water task forces and initiatives and overlapping councils, and bring back a simplified process for dealing with water issues.

## **6. ACTION ITEMS**

### **A Proposed 2021 JPA Board Meeting Calendar**

**Review the proposed 2021 JPA Board Meeting Calendar and make any scheduling adjustments.**

Josie Guzman, Executive Assistant/Clerk of the Board, presented the report.

The JPA Board discussed keeping the May 3, 2021 meeting, canceling the September 7, 2021 meeting, and scheduling a Special meeting on September 13, 2021.

Director Tjulander moved to approve the 2021 JPA Board Meeting Calendar as amended. Motion seconded by Director Polan. Motion carried unanimously by roll call vote.

### **B Tapia Tertiary Filter Media Replacement: Authorization of Purchase Order**

**Authorize the Administering Agent/General Manager to issue a purchase order to Prominent Systems, Inc., in the amount of \$107,754, for replacement of tertiary filter media at the Tapia Water Reclamation Facility.**

Administering Agent/General Manager David Pedersen presented the report.

Director Lo-Hill moved to approve Item 6B. Motion seconded by Director Orkney. Motion carried unanimously by roll call vote.

## **C Pure Water Project Las Virgenes-Triunfo: Proposed Mascot**

**Review and provide feedback on the proposal for a JPA-centric mascot for the Pure Water Project Las Virgenes-Triunfo.**

Mike McNutt, Public Affairs and Communications Manager, presented the report and recommended that the Board consider “Super Drop” as the mascot for the Pure Water Project Las Virgenes-Triunfo based on a previously developed concept called “The League of Water Warriors.”

Director Lo-Hill moved to approve Item 6C as recommended. Motion seconded by Director Tjulander.

Director Orkney spoke in support of having iridescent blue tones for the mascot’s costume, and asked that Super Drop’s face be happier rather than as depicted in the rendering.

Director Lo-Hill spoke in support of the super hero theme.

Motion carried unanimously by roll call vote.

## **D Rancho Solar Generation Project Phase II: Award of Construction Contract for Landscaping Improvements**

**Award a construction contract to Martinez Landscaping Company, Inc., in the amount of \$70,230, and reject all remaining bids upon receipt of duly executed contract documents; and authorize the Administering Agent/General Manager to approve Change Order No. 2 for Envicom Corporation, in the amount of \$11,759.50, for additional environmental services for the Rancho Solar Generation Project Phase II.**

Eric Schlageter, Principal Engineer, presented the report.

Director Polan moved to approve Item 6D. Motion seconded by Director Wall.

Mr. Schlageter responded to a question regarding the lifecycle of the plant materials and irrigation by stating that there would be a one-year warranty period that would be in effect during irrigation, as well as a 90-day post-construction period where the contractor would be responsible for maintaining all of the plants and landscaping.

John Zhao, Director of Facilities and Operations, responded to a question regarding whether the archeological and Native American artifacts were carbon dated by stating that no carbon dating was done; however, the archeologist placed the artifacts’ time period to be over 800 years.

Motion carried unanimously by roll call vote.

**E Farm Sprayfield Operation and Maintenance: Authorization of Agreement**

**Authorize the Administering Agent/General Manager to execute a one-year agreement with W. Litten Land Preparation, in an amount not-to-exceed \$384,900, for operation and maintenance of the Rancho Las Virgenes Farm Sprayfields.**

Administering Agent/General Manager David Pedersen provided a brief summary.

Dave Roberts, Resource Conservation Manager, presented the report and PowerPoint presentation.

Director Shapiro moved to approve Item 6E. Motion seconded by Director Caspary.

A discussion ensued regarding the Department of Industrial Relations' (DIR) determination in denying the request for a special wage determination for operation and maintenance of the Rancho Las Virgenes Farm Sprayfields as it had opined that the work falls within the scope of existing prevailing wage classifications as a public works project.

Motion carried unanimously by roll call vote.

**F Rancho Las Virgenes Composting Facility Centrifuge No. 2 Repairs: Award of Purchase Order**

**Accept the quotation from CentriTEK and authorize the Administering Agent/General Manager to issue a purchase order, in the amount of \$69,669.86, for repairs to Centrifuge No. 2 at the Rancho Las Virgenes Composting Facility.**

John Zhao, Director of Facilities and Operations, presented the report.

Director Polan moved to approve Item 6F. Motion seconded by Director Caspary.

Mr. Zhao responded to a question regarding the lifecycle of the centrifuge by stating that the centrifuge could last more than 15 years with proper maintenance.

Motion carried unanimously by roll call vote.

**7. BOARD COMMENTS**



Director Lo-Hill reported that she attended the virtual tour of the Alameda County Water District's Fish Passage Project.

**8. ADMINISTERING AGENT/GENERAL MANAGER REPORT**

Administering Agent/General Manager David Pedersen noted that the creek avoidance period would end on November 15th. He reported that the flow in Malibu Creek measured 6.3 cubic feet per second (CFS) at the gauging station; therefore, fish flow was not needed. He noted that red flag weather conditions occurred the previous week, and no power outages affected JPA-owned facilities. He also reported that he would provide a presentation regarding the Pure Water Project Las Virgenes-Triunfo during the Association of California Water Agencies (ACWA) Region 8 program on November 3rd.

**9. FUTURE AGENDA ITEMS**

Director Polan inquired regarding a future agenda item related to Michael Hart's proposal for a memorial park at the Rancho Las Virgenes Farm Sprayfields. Administering Agent/General Manager David Pedersen responded that Mr. Hart would provide a presentation at the November 17, 2020 Las Virgenes Municipal Water District Board of Directors Meeting. He noted that Mr. Hart's proposal was originally presented under Public Comment as a potential use of the farm, and it might be of interest to the JPA.

**10. INFORMATION ITEMS**

**A Cordillera Tank Rehabilitation Project: Construction Award**

**B Management of Water Quality at the Las Virgenes Reservoir**

**11. PUBLIC COMMENTS**

None.

**12. ADJOURNMENT**

Seeing no further business to come before the Board, the meeting was duly adjourned at **6:19 p.m.**

---

Jay Lewitt, Chair

ATTEST:

---

James Wall, Vice Chair

December 7, 2020 JPA Board Meeting

TO: JPA Board of Directors

FROM: General Manager

---

**Subject : Project of the Year Award for Tapia Process Air Improvements  
Project: Presentation by Shahn Ahmad, APWA Regional Director**

---

**SUMMARY:**

After the successful completion of the Tapia Process Air Improvements Project, JPA staff and the project engineer with Pacific Advanced Civil Engineering, Inc. (PACE) nominated the work for awards offered by the American Public Works Association (APWA), American Council of Engineering Companies (ACEC) and California Water Environment Association (CWEA). Staff and PACE engineers not only wanted to share the JPA's success story but, more importantly, wanted to provide a roadmap for industry peers on successfully upgrading aging water reclamation infrastructure to achieve a short return on investment (5.7 years) and large cost-savings (\$2.5 million) from reduced maintenance and energy expenditures over the expected project lifecycle.

Staff is excited to report that the project received the coveted BEST Project of the Year Award from APWA of Southern California for Water/Wastewater/Drainage Projects of comparable size. The project also received a Commendation Award in the ACEC California 2021 Engineering Excellence Award Competition. Attached for reference is the project summary and application submitted for the ACEC Award. Staff is still waiting to hear back from CWEA.

**FISCAL IMPACT:**

No

**ITEM BUDGETED:**

No

Prepared by: John Zhao, P.E, Director of Facilities and Operations

**ATTACHMENTS:**

ACEC Award Submittal

# EXECUTIVE SUMMARY

## PROJECT TITLE

**Las Virgenes – Triunfo Joint Power Authority Tapia Water Reclamation Facility Process Air Improvements.**

## ENTRY CATEGORY F **Water and Storm Water**

Under contract with the Las Virgenes Municipal Water District (LVMWD) PACE Advanced Water Engineering (PACE) performed a facility evaluation and design services to improve the efficiency and reduce operational costs of the existing 12 MGD Tapia Water Reclamation Facility by making improvements to its Process Air System. PACE evaluated the existing conditions, including the existing treatment process, blower performance, as-built drawings, and SCADA data (DO Profiles) as well as spent time with the Operations Staff to better understand the challenges and identify any ancillary issues. The improvements recommended and implemented included over 60 retrievable, fine bubble aeration grids; three 400HP magnetic-bearing turbine blowers; conversion of 4160 medium voltage electrical gear down to 480V; and SCADA/controls integration to optimize process controls. These improvements reduced energy consumption by almost 40%.

The project delivery featured a Performance Specifications process, which is an equipment selection process that allows entities to get competitive bids, evaluate capital and operational costs, and determine operational performance prior to design. This process ensured high quality equipment



was selected with lucrative performance guarantees and led to competitive bidding that reduced capital costs by approximately \$300,000.

Additionally, a special Sequence of Construction was implemented allowing for construction to take place while maintaining facility operation to continue to treat wastewater flows without generating any discharge permit violations. The construction of the improvements was completed in 2019 (ahead of schedule) with a projected return on investment of approximately 5.7 years and an estimated savings of \$2.5M over the 20 year expected life of the blowers.

# PROJECT DESCRIPTION

## Project Objectives

The Las Virgenes – Triunfo Joint Power Authority (JPA) owns and operate the Tapia Water Reclamation Facility (WRF) located in Calabasas, CA. The facility has a design capacity of 12 MGD utilizing a 4-Stage Bardenpho Activated Sludge Treatment Process. The facility produces effluent that meets CA Title 22 Disinfected Tertiary Recycle Water Standards. The JPA distributes the effluent for beneficial reuse throughout its service area using their vast recycled water distribution network. The surrounding communities rely on the recycled water to help conserve their limited potable water supply. As a result, improvements that greatly improve the efficiencies at the Tapia WRF, whether it is process efficiency, operational efficiency, or energy efficiency, is of great importance to the JPA. The Process Air Improvement Project is a unique project as it achieves improvements in all three target efficiency areas.

Process air at Tapia is used to support the biological processes and to provide mixing in the aeration basins, re-aeration basins, primary influent feed channels, and four process and selector channels. Process air is also used to provide scouring air for filter backwashing. Currently, there are six blowers at Tapia which are used to provide air to all of the processes. Three Roots 900 HP centrifugal blowers (22,500 cfm) provide process air during periods of high demand. There are also three Hoffman 250 HP centrifugal blowers (4,500 cfm) which provide process air during low demand periods and supplement the Roots blowers. The Hoffman blowers were installed in the 1970's and the Roots blowers were installed in the 1980's. The blowers installed were not equipped with variable speed drives (VFDs).

Due to the age of the blowers, the JPA recognized that the blowers needed to be evaluated to determine if some or all of the blowers required repair or replacement.



## Firm's Role in the Project

PACE was selected by the JPA to serve as the Design Engineer responsible for the evaluation and design of the Process Air Improvements at the Tapia WRF. PACE evaluated the existing Process Air System, identified deficiencies, and recommended improvements. Once approved by the JPA, PACE provided construction documents that included detailed Engineering Plans (including mechanical, process and instrumentation, and electrical design), technical specifications, and design reports. During the construction phase, PACE assisted the JPA with construction services for submittal reviews, RFI response and clarifications, site inspection, and system startup.

### Project Team Members and Roles

**Project Manager/ Design Engineer**  
PACE, Fountain Valley, CA

**Electrical Engineer**  
PACE, Fountain Valley, CA

**Controls and Instrumentation Consultant** MSO Technologies, Inc,  
Thousand Oaks, CA

**Construction Contractor**  
Cushman Contracting Corporation,  
Santa Barbara, CA

# Firm's Contribution

## Original/Unique/Innovative Application of New or Existing Technologies

*A unique project approach was applied recognizing the impacts of other components and equipment on the overall efficiency of the Process Air System, resulting in improvements to the fine bubble aeration system and biological process controls system.*

PACE's evaluation identified that over 70% of the process air was used for the biological oxidation process, and of that, 80% was used by the secondary process alone. This indicated that any improvement to the process air system would also require improvements to the air delivery system within the biological process. PACE evaluated the existing fine bubble spiral-roll aeration system installed within each secondary process basin and determined that replacing the existing aeration system with

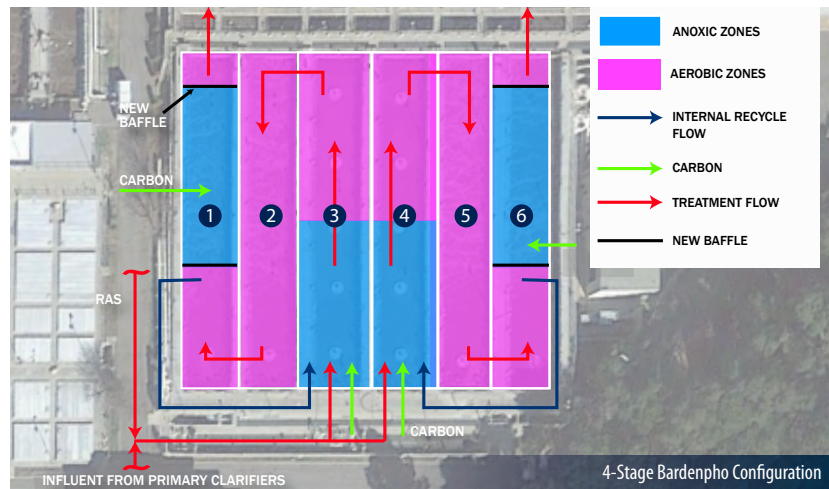

new full-coverage, fine bubble aeration grids would reduce the air flow requirement by approximately 30%. PACE used Performance-Based Specifications, which is an equipment selection process that allows entities to get competitive bids, evaluate capital and operational costs, and determine operational performance prior to design. This process ensured high quality equipment was selected with lucrative performance guarantees and led to competitive bidding that reduced capital costs by approximately \$300,000. The OTT Fine Bubble Retrievable Aeration System was selected and uses silicon-based membranes to achieve Oxygen Transfer Efficiency of over 30% (one of the highest in the industry). The silicon-based material also reduces biological fouling and scaling. The retrievability of the aeration grids allows the operation staff to inspect and maintain the system, thus improving the life span and efficiency of the equipment.



To replace the aging centrifugal blowers, PACE evaluated different blower technologies including high efficiency air bearing and magnetic bearing turbine blowers, multistage centrifugal blowers (similar to the existing blowers but more advanced with higher efficiency), and single-stage, integrally geared, centrifugal blowers. Using Performance-Based Specifications, PACE evaluated and recommended the use of high efficiency, magnetic-bearing, turbine blowers manufactured by Sulzer. The new turbine blowers have an efficient of approximately 70-80% compared to new multistage centrifugal blowers (similar to the existing blowers) with efficiency of approximately 50-70%.

The combination of new fine bubble aeration and new magnetic-bearing turbine blowers is estimated to save the JPA between 30-40% in power cost alone. However, to further improve the biological process and to further improve energy efficiency, PACE implemented a new control strategy using new field instrumentation that is networked back to the blowers and process valves. The biological process requires distinct aerobic and anoxic zones to properly remove nutrients in the water. The field instrumentation, consisting of dissolved oxygen (DO) probes, oxidation potential-reduction (ORP) probes, and pressure sensors monitor the oxygen and air requirements and adjust the process air valves and blowers to obtain the optimum condition for treatment.

## UNIQUE APPLICATION OF DIFFERENT TECHNOLOGY, TECHNIQUE, MATERIALS OR EQUIPMENT

PACE applied a unique equipment selection technique called **Performance-Based Specifications** that was developed over ten years ago to help evaluate and select major process equipment at a significantly reduced capital cost without sacrificing quality. Equipment is a major capital cost that is difficult to control. Equipment, especially those used in WWTPs, need to be of the highest quality due to the harsh conditions of the facilities. However, vendors of high quality equipment often patent their equipment, resulting in essentially “sole-sourcing” their equipment if specifications are written around their equipment. This allows them to have higher margins on their equipment and thus increases the cost of the project. Instead, the Performance-Based Specifications process ensured the project would benefit substantially from a competitive, performance-based equipment selection process **prior to performing full design**.

In a typical project, where the facility is designed around one type of equipment, there is a high probability that the final cost of the project will be higher than if competitive bidding were performed. However, waiting until the design is completed to allow competitive bidding on the equipment reduces the interest of potential suppliers and typically requires substantial re-design to implement; making contractors less likely to propose value-added alternatives. The use of Performance-Based Specifications in the equipment selection process allows project equipment to be competitively bid with an evaluation that includes capital costs, operational costs and operational performance.

The other major advantage is that the project team can proceed to design knowing the exact equipment they will be using in the project. This minimizes conflict in the design and reduces potential construction change orders.

***The JPA was able to save approximately \$300,000 in equipment cost using Performance-Based Specifications for the selection of the Process Air Blowers and the Fine Bubble Aeration Diffusers.***

## Future Value to the Engineering Profession & Public Perception

The processes undertaken in this project ensured the project yielded the highest value not just at the time of construction, but well into the future based on an approach that considered both current and future costs and value. Two main approaches yielded the highest value over the lifespan of the facility:

**1** First, is the integration of the energy efficiency in the process design. Even though the initial intent of the project was to replace aging blowers, PACE and the JPA recognized that replacing the existing aeration system with a more efficient system will further reduce the air requirement, thus reducing the size of the blower. This benefited the JPA with reduced capital cost from a smaller blowers and reduced power cost from a lower air requirement and more efficient blower.

**2** Second, is the implementation of Performance-Based Specifications to evaluate and design equipment based on best overall value prior to design. This is much different from the tradition design-bid-build approach. Using the Performance-Based Specifications, the JPA was able select equipment with an overall value (performance, cost) specific to the project’s objective prior to any design being performed. This allows the JPA and the Project Team to know the exact equipment that will be designed and installed.

The District benefited from positive public perception by demonstrating highly responsible and cost effective improvement approaches that yielded both capital and long-term operations cost savings. Additionally, the public benefits from the reduced energy use, which in addition to cost benefits, reduces the facility’s carbon footprint and represents environmental sustainability.

## Social, Economic, and Sustainable Design Considerations

The Process Air Improvement Project exemplifies the environmental stewardship that can be accomplished with a wastewater treatment facility. The improvement project ensures that the Tapia WRF can continue to treat wastewater to high effluent quality and provide a valuable recycled water source for the community that reduces demand on limited potable water supplies. Additionally, the energy efficiency improvements with the Process Air System allows the facility to provide this treatment and commodity with 30-40% less electrical energy significantly reducing the facility's carbon footprint. Other benefits realized with the Process Air System Improvements includes improved nutrient removal process performance and improved maintenance capability with the installation of retrievable fine bubble aeration grids. Overall, the community benefits from a reasonable capital expense outlay with a return on investment of less than 6 years and an estimated savings of \$2.5M over the 20-year expected life of the new system.

### Complexity

The 900 HP Roots blowers previously in place used 4160 medium voltage and were located within individual blower bays with limited egress. The design had to incorporate the removal of the blowers and installation of the new 400 HP, 480V blowers, along with step-down transformers. The electrical design was complex due to congested existing conduits and limited space within each bay to install the new blowers along with the transformer, harmonic filters, and other ancillary electrical components. PACE also identified increased ventilation requirements and made modifications to improve the ventilation system. All of these improvements, along with the new equipment needed to be installed without disrupting the operation of the facility.



Previous 900 HP Roots Blower inside Blower Bay

In order to install the new retrievable fine bubble diffusers, the six (6) secondary biological basins needed to be isolated, drained, and cleaned. PACE worked with the operation staff and developed a Sequence of Construction Plan that took into account the physical constraints of the isolating and draining the basin, the treatment process constraints of maintaining operation and providing treatment during construction, and permitting constraints that limited discharge options during certain times of the year. The Sequence of Construction Plan was implemented and performed as intended without any construction issues or permit violations.

PACE developed a new control strategy and Fiber Optic network design that allowed for automation of the aeration system and blowers based on the DO requirements of each Secondary Aeration Basin. The strategy allows the adjustment of the air flow, blower speed, and valve positions





Secondary Biological Treatment Trains removed and out of service for installation of new Retrievable Fine Bubble Aeration Grids

seamlessly through a network of local Remote Telemetry Units (RTU) equipped with network PLCs. The local RTUs allow for direct digital and analog communication with field instruments and local process valves, while communication between the RTUs and the blower PLCs are on a separate high speed ethernet communication network. This reduces the data congestion that can bog down the network and make the control ineffective.

## Exceeding Owner/Client Needs

The PACE Design Team worked closely with the JPA Staff to evaluate the Tapia WRF, as a whole, recognizing the inter-relationship between the process air system, the biological system, and the process controls. PACE was able to introduce a unique approach to equipment selection and procurement that resulted in over \$300,000 in capital cost savings. The improvements to the Process Air System, along with upgrades to the Fine Bubble Aeration System and Controls Integration Upgrades allowed the JPA to realize an energy savings of 30-40%. This translates to an estimated energy savings of approximately \$2.5M over the design life of 20 years with a 5.7-year payback period. All of this was completed ahead of schedule and within budget. John Zhao, Director of Facilities and Operations, stated that “this project greatly exceeded the expectations of the JPA and serves as a model project on how a public agency can update aging infrastructure and improve reliability while providing overall energy savings.”

***“This project greatly exceeded the expectations of the JPA and serves as a model project on how a public agency can update aging infrastructure and improve reliability while providing overall energy savings.”***

— John Zhao, Director of Facilities and Operations



Previous Old Roots Blower



New Turbo Blower with Smaller Footprint



Congested Electrical Conduits Leading to Blower Bays



Startup and testing of new Fine Bubble Aeration Grids



**BEST BEST & KRIEGER**   
ATTORNEYS AT LAW

To: Las Virgenes -Triunfo JPA  
 From: Syrus Devers, Best Best & Krieger  
 Date: November 20, 2020  
 Re: Election Summary

**Brief Conclusion:** Although the presidential election results captured everyone's attention, and the Democrats celebrated in the streets, the overall results in California amount to a narrow victory for the Republicans.

**State Assembly:** Going into the elections the Democrats held 61 seats in the Assembly. They had practically already counted the wins in AD 68 (Orange County) where Steven Choi (R) looked completely vulnerable, and they had their sights on Phillip Chen (R) in AD 55 (Orange County) as well. But when the votes were counted both men held their seats by a comfortable 10% margin. Worse for the Democrats was being locked out of the race in AD 38 (Santa Clarita) where Christy Smith (D), who was just elected in 2018, decided to vacate the seat to launch a losing bid for Congress. Two Republicans took the top two spots in the primary and Suzette Martinez Valladares (R) will replace Smith. Former Minority Leader Chad Mayes switched his ballot designation to No Party Preference (NPP) and easily beat his Republican challenger. The 2021 Assembly will be 60 D's, 19 R's, and 1 NPP.

**State Senate:** The only bright spot for the Democrats, besides winning the White House (eventually...one can only hope), was the State Senate. Republican Senators John Moorlach (SD 37) and Ling Ling Chang (SD 29), both from Orange County, lost their reelection bids to Democrat challengers. Chang lost her seat to John Newman, who won it against her in 2016, only to be replaced Chang in 2018 following a successful recall effort following Newman's vote in favor of a tax increase. Moorlach will be replaced by Democrat Dave Minn. The Senate party counts will then be 30 Dems to 9 Reps and 1 vacancy due to Sen. Holly Mitchell winning an L.A. Supervisor seat.

**Ballot Measures:** There is no nice way to say it--on the ballot initiatives the Democrats got their heads handed to them on a plate. By the numbers, Democrats won about half of the ballot measures where the party took a position, but that doesn't tell the real story because not all the initiatives were of equal weight. Of the seven that really mattered to the progressive party, Democrats only won two, and even those were not the top priorities. They won on Prop. 19, which changes inheritance tax rules and allows for a transfer of property tax benefits, and they opposed and won on Prop. 20 related to parole sentencing. But the big issues were Prop. 15 to remove commercial property from the Prop. 13

**BB&K**  
**BEST BEST & KRIEGER**   
ATTORNEYS AT LAW

protections (also known as “split roll”), Prop. 16 to reinstate affirmative action, Prop. 21 to expand rent control, Prop. 22 to overturn the statute that made Uber and Lyft drivers employees instead of independent contractors (probably the top priority), and finally Prop. 25, which was a referendum on the statute to eliminate bail. The electorate went against the Democrat recommendations on every one. (Ouch)

**Conclusion:** Combined with the losses the Democrats suffered at the federal level, the overall results of the 2020 General Election were a clear, albeit narrow, victory for the conservatives. BB&K does not expect any of the changes to affect Las Virgenes’s or Triunfo’s interests in the Legislature since there will likely be only modest changes to the composition of the policy committees. The only possible change, and no one outside of Senate leadership would know, would be if Sen. Henry Stern wanted to do something other than Chair Sen. Natural Resources. Former Assembly Member and former Director of the State Natural Resources Agency John Laird won his bid for the seat vacated by Bill Monning in Monterey/Santa Cruz area, and he would, no doubt, like to put his considerable expertise in natural resources to good use. But with so many Democrats in the Senate, committee chairs will be highly prized. Odds are that Sen. Stern would do well to keep the committee he has, but such matters are far above the paygrade of BB&K staff.



**BEST BEST & KRIEGER**  
ATTORNEYS AT LAW

**To:** Las Virgenes-Triunfo JPA Staff and Board of Directors  
**From:** John Freshman, Ana Schwab, and Lowry Crook  
**Date:** November 21, 2020  
**RE:** Federal Report

**Congressional Schedule**

The Senate and House will be on recess during the week of November 23 for Thanksgiving. The Senate and House will return on November 30.

Upon returning from recess, the Senate and House will be negotiating a potential omnibus appropriation package for fiscal year 2021, the National Defense Authorization Act (NDAA), Water Resources Development Act (WRDA) and a potential COVID-19 relief package.

Currently, the House is scheduled to be in session through December 10, and the Senate through December 18.

**COVID-19 Relief**

Yesterday, the Republican leaders for the House and Senate met with Treasury Secretary Mnuchin and other Administration officials to discuss their opening position and strategy for post-election negotiations with the Democrats. Senate Majority Leader McConnell wants the starting point of negotiations to be the \$500 billion package offered by Republicans before the election. House Speaker Pelosi has remained firm on the House's \$2.2 trillion package. Speaker Pelosi and Minority Leader Schumer continue to insist that more funding should be provided for states and local governments, which Republicans have opposed.

**Fiscal Year 2021 Appropriations**

Last week, the Senate released their proposed appropriations allocations and bills for fiscal year 2021 appropriations. This week, House and Senate appropriators have been working to agree on top-line allocations for the 12 appropriations bills. If they can agree on those allocations, they plan to negotiate the individual bills between November 30 and the expiration of the current Continuing Resolution that is funding the government through December 11. All sides have stated that they hope to agree on an omnibus appropriations bill in December rather than pass another Continuing Resolution into the Biden Administration. Those hopes face the headwinds of the short calendar and Democratic incentives to wait out any significant demands by the Trump Administration. Current Administration demands that may hold up an omnibus in December include border wall funding in the Homeland Security bill and a dispute between the Administration and Democrats over whether to classify \$12.5 billion in additional Veterans Affairs funding as regular spending under agreed spending caps or emergency spending not subject to those caps.

Where they stand on key water funding programs:



**BEST BEST & KRIEGER**  
ATTORNEYS AT LAW

- The Senate proposals do not include the \$10 billion in emergency State Revolving Funds or \$3 billion in emergency Bureau of Reclamation funds proposed in the House Interior and Environment and Energy and Water bills that were passed in July.
- The Senate’s Interior and Environment appropriations bill includes \$60 million in new funding for the WIFIA loan program, and it omits the House’s language that would rescind and re-appropriate WIFIA funds for loans that have not closed.

**Funding Levels for Key Programs**

<b>Agency / Program</b>	<b>Enacted FY2020</b>	<b>House FY2021 (passed)</b>	<b>Senate FY2021 (introduced)</b>
<b>EPA</b>	\$9.06 B	\$9.38 B	\$9.09 B
<i>WIFIA</i>	\$60 M	\$0	\$60 M
<i>Drinking Water State Revolving Funds</i>	\$1.13 B	\$1.13 B	\$1.126 B
<i>Clean Water State Revolving Funds</i>	\$1.64 B	\$1.84 B	\$1.639 B
<b>Bureau of Reclamation</b>	\$1.68 B	\$1.64 B	\$1.69 B
<i>Title XVI</i>	\$63.6 M	\$63.7 M	\$63.6 M
<i>WaterSMART</i>	\$55 M	\$60 M	\$55 M

**Water Resources Development Act**

The Water Resources Development Act is still on track to pass during the lame-duck session. This week, House and Senate negotiators completed their negotiations, and the week after Thanksgiving they plan to introduce a new bill in the House based on their agreed positions.

**Defense Reauthorization**

Congress is also working to pass the 2021 National Defense Authorization Act (NDAA) in the lame duck session. Neither the House nor the Senate bills include provisions that would designate PFAS as a hazardous substance under the Comprehensive Environmental Response, Compensation, and Liability Act (CERCLA), and we do not expect such a provision to be included in a final bill this year. The bill will include funding increases for the cleanup of PFAS contamination from military bases and PFAS-related research.



The only significant remaining hurdle for the bill is disagreement between Congress and the Administration over a provision that would require the Pentagon to change the names of military bases and other properties that are named after Confederate leaders.

### **Issues for Incoming Biden Administration and New Congress**

Key issues that we are tracking and preparing for in 2021 include:

- *Stimulus and Infrastructure:* President-elect Biden plans to propose an infrastructure package in 2021. As Vice President, Biden was a consistent internal and external advocate for water infrastructure investments. His campaign proposals have consistently included water infrastructure investments, though with an emphasis on resilience to climate change, drinking water safety and affordability for disadvantaged communities, and environmental justice. An infrastructure package's prospects depend on the stance taken by Senate Republicans, as well as the outcome of the two Senate seats that will be decided by the special election in Georgia on January 5, 2021. We need to work to identify projects and maximize their prospects for securing funding if an infrastructure package passes.
- *Earmarks:* The three House Democrats running to chair the House Appropriations Committee are all committed to bringing back Congressionally directed spending on specific projects, or earmarks, along with transparency requirements. The House Rules' ban on earmarks ended in 2019, but outgoing House Appropriations Chair Lowey excluded earmarks in the past two rounds of appropriations following concerns raised by moderate Democratic members. The Senate's rules still permanently ban earmarks, though Senate Appropriations Chair Shelby favors ending the ban. Earmarks included in House bills will be a new subject of negotiation with the Senate.
- *Drinking Water and Environmental Regulation:* We expect efforts in Congress and by the Biden Administration next year to establish limits for PFOA and PFOS in drinking water, designate PFOA and PFOS as hazardous substances under CERCLA, and regulate them under the Clean Water Act. We also expect the Biden Administration to restore federal Clean Water Act jurisdiction over ephemeral streams and wetlands. And we expect the Biden Administration to reverse a wide range of environmental rollbacks by the Trump Administration, though many of those reversals will take more than a year. Senate Republicans will attempt to stop these reversals through restrictive appropriations riders – another subject for negotiation in the appropriations process.

**LAS VIRGENES TRIUNFO - HIGH PRIORITY LEGISLATION IN THE 116TH CONGRESS  
THROUGH NOVEMBER 20, 2020**

LEGISLATION	SUMMARY	STATUS	POSITION
<a href="#"><u>H.R. 34</u></a> <a href="#"><u>Energy and Water Research Integration Act of 2019</u></a>	<p>To ensure consideration of water intensity in the Department of Energy’s energy research, development, and demonstration programs to help guarantee efficient, reliable, and sustainable delivery of energy and clean water resources.</p>	<p>Introduced by Rep. Eddie Bernice Johnson (D-TX) – January 3, 2019</p> <p>Passed/agreed to in the House – July 23, 2019.</p> <p>Introduced in the Senate</p>	
<a href="#"><u>S. 47</u></a> <a href="#"><u>Natural Resources Management Act</u></a>	<p>This bill sets forth provisions regarding various programs, projects, activities, and studies for the management and conservation of natural resources on federal lands.</p> <ul style="list-style-type: none"> <li>• Specifically, the bill addresses, among other matters</li> <li>• land conveyances, exchanges, acquisitions, withdrawals, and transfers;</li> <li>• national parks, monuments, memorials, wilderness areas, wild and scenic rivers, historic and heritage sites, and other conservation and recreation areas;</li> <li>• wildlife conservation;</li> <li>• helium extraction;</li> <li>• small miner waivers of claim maintenance fees;</li> <li>• wildland fire operations;</li> <li>• the release of certain federal reversionary land interests;</li> <li>• boundary adjustments;</li> <li>• the Denali National Park and Preserve natural gas pipeline;</li> <li>• fees for medical services in units of the National Park System;</li> <li>• funding for the Land and Water Conservation Fund;</li> <li>• recreational activities on federal or nonfederal lands;</li> <li>• a national volcano early warning and monitoring system;</li> <li>• federal reclamation projects; and</li> <li>• search-and recovery-missions.</li> </ul> <p>In addition, the bill reauthorizes the National Cooperative Geologic Mapping Program.</p>	<p>Introduced by Sen. Lisa Murkowski (R-AK) – January 8, 2019</p> <p>Became Public Law No: 116-9 – March 12, 2019</p>	

LEGISLATION	SUMMARY	STATUS	POSITION
<a href="#">S. 40</a> <a href="#">Bureau of Reclamation Transparency Act</a>	To require the Secretary of the Interior to submit to Congress a report on the efforts of the Bureau of Reclamation to manage its infrastructure assets.	Introduced by Sen. John Barrasso (R-WY) – January 8, 2019	
<a href="#">H.R. 357</a> <a href="#">Sacramento-San Joaquin Delta National Heritage Area Act</a>	To establish the Sacramento-San Joaquin Delta National Heritage Area. The boundaries of the Heritage Area shall be in the counties of Contra Costa, Sacramento, San Joaquin, Solano, and Yolo in the State of California, as generally depicted on the map entitled “Sacramento-San Joaquin Delta National Heritage Area Proposed Boundary”, numbered T27/105,030, and dated October 2012.	Introduced by Rep. John Garamendi (D-CA) – January 9, 2019  Signed into law on March 12, 2019 as part of S. 47 – Natural Resources Management Act	
<a href="#">H.R. 535</a> <a href="#">PFAS Action Act of 2019</a>	To require the Administrator of the Environmental Protection Agency to designate per- and polyfluoroalkyl substances as hazardous substances under the Comprehensive Environmental Response, Compensation, and Liability Act of 1980.	Introduced by Rep. Debbie Dingell (D-MI) – January 14, 2019  Received in the Senate – January 13, 2020	
<a href="#">H.R. 579</a> <a href="#">Water Rights Protection Act of 2019</a>	To prohibit the conditioning of any permit, lease, or other use agreement on the transfer of any water right to the United States by the Secretaries of the Interior and Agriculture, and for other purposes.	Introduced by Rep. Scott Tipton (R-CO) – January 15, 2019	
<a href="#">H.R. 664</a> <a href="#">Recreational Lands Self-Defense Act of 2019</a>	To protect the right of individuals to bear arms at water resources development projects administered by the Secretary of the Army, and for other purposes	Introduced by Rep. Bob Gibbs (D-OH) – January 17, 2019	



LEGISLATION	SUMMARY	STATUS	POSITION
<a href="#">H.R. 667</a> <a href="#">Regulatory Certainty for Navigable Waters Act</a>	To repeal the Waters of the United States rule and amend the Federal Water Pollution Control Act	Introduced by Rep. Jamie Herrera Beutler (R-WA) – January 17, 2019	
<a href="#">H.R. 658</a> <a href="#">National Infrastructure Development Bank Act of 2019</a>	To facilitate efficient investments and financing of infrastructure projects and new job creation through the establishment of a National Infrastructure Development Bank, and for other purposes. Highlighting environmental infrastructure projects which include drinking water, waste water treatment facility, and stormwater management system.	Introduced by Rep. Rosa DeLauro (D-CT) – January 17, 2019	
<a href="#">H.R. 807</a> <a href="#">Water and Agriculture Tax Reform Act of 2019</a>	To amend the Internal Revenue Code of 1986 to facilitate water leasing and water transfers to promote conservation and efficiency.	Introduced by Rep. Ken Buck (R-CO) – January 28, 2019	
<a href="#">H.R. 843</a> <a href="#">Reform EPA Act</a>	To amend the Federal Water Pollution Control Act to clarify when the Administrator of the Environmental Protection Agency has the authority to prohibit the specification of a defined area, or deny or restrict the use of a defined area for specification, as a disposal site under section 404 of such Act, and for other purposes.	Introduced by Rep. Bob Gibbs (R-OH) – January 29, 2019	
<a href="#">H.R. 855</a> <a href="#">STRONG Act</a>	To minimize the economic and social costs resulting from losses of life, property, well-being, business activity, and economic growth associated with extreme weather events by ensuring that the United States is more resilient to the impacts of extreme weather events in the short- and long-term, and for other purposes. Key sectors shall include water management, including supply and treatment; infrastructure, including natural and built forms of water and wastewater services;	Introduced by Rep. Scott Peters (D-CA) – January 29, 2019	
<a href="#">S. 308</a> <a href="#">Santa Ana River Wash Plan Land Exchange Act</a>	A bill to direct the Secretary of the Interior to convey certain Federal lands in San Bernardino County, California, to the San Bernardino Valley Water Conservation District, and to accept in return certain non-Federal lands, and for other purposes	Introduced by Sen. Dianne Feinstein (D-CA) – January 31, 2019	
<a href="#">S. 361</a> <a href="#">Water and Agriculture Tax Reform Act of 2019</a>	A bill to amend the Internal Revenue Code of 1986 to facilitate water leasing and water transfers to promote conservation and efficiency.	Introduced by Sen. Cory Gardner (R-CO) – February 6, 2019	

LEGISLATION	SUMMARY	STATUS	POSITION
<a href="#"><u>H.R. 1067</u></a> <a href="#"><u>Santa Ana River Wash Plan Land Exchange Act</u></a>	<p>To direct the Secretary of the Interior to convey certain Federal lands in San Bernardino County, California, to the San Bernardino Valley Water Conservation District, and to accept in return certain non-Federal lands, and for other purposes.</p>	<p>Introduced by Rep. Pete Aguilar (D-CA) – February 7, 2019</p>	
<a href="#"><u>S. 376</u></a> <a href="#"><u>Defense of Environment and Property Act of 2019</u></a>	<p>A bill to amend the Federal Water Pollution Control Act to clarify the definition of navigable waters, and for other purposes.</p>	<p>Introduced by Sen. Rand Paul (R-KY) – February 7, 2019</p>	
<a href="#"><u>H.R. 1137</u></a> <a href="#"><u>To amend the Water Resources Development Act of 1986 to repeal the authority relating to reprogramming during national emergencies.</u></a>	<p>To amend the Water Resources Development Act of 1986 to repeal the authority relating to reprogramming during national emergencies.</p>	<p>Introduced by Rep. John Garamendi (D-CA) – February 11, 2019</p>	
<a href="#"><u>H.R. 1162</u></a> <a href="#"><u>Water Recycling Investment and Improvement Act</u></a>	<p>To extend the authorization of the Bureau of reclamation’s Title XVI competitive grants program, and increases the authorized funding levels from \$50 million to \$500 million. Further the legislation expands the geographic scope of the program by removing a requirement that projects be located in sustained drought or disaster areas, makes the program truly competitive by removing a requirement that Congress sign off on each selected project, and modernizes the individual program funding cap from \$20 million to \$30 million.</p>	<p>Introduced by Rep. Grace Napolitano (D-CA) –  Introduced February 13, 2019   Ordered to be Reported (Amended) –  March 11, 2020</p>	<p><i>Support</i></p>
<a href="#"><u>H.R. 1334</u></a> <a href="#"><u>Outdoor Recreation Legacy Partnership Grant Program Acts</u></a>	<p>To provide grants for projects to acquire land and water for parks and other outdoor recreation purposes and to develop new or renovate existing outdoor recreation facilities.</p>	<p>Introduced by Rep. Nanette Barragan (D-CA) – February 25, 2019</p>	

LEGISLATION	SUMMARY	STATUS	POSITION
<a href="#">H.R. 1331</a> <a href="#">Local Water Protection Act</a>	<p>To amend Section 319(j) of the Federal Water Pollution Control Act ( 33 U.S.C. 1329 (j)) is amended by striking “subsections (h) and (i) not to exceed” and all that follows through “fiscal year 1991” and inserting “subsections (h) and (i) \$200,000,000 for each of fiscal years 2020 through 2024”.</p>	<p>Introduced by Rep. Annie Craig (D-MN) – February 26, 2019</p> <p>Passed/agreed to in House - April 8, 2019. Introduced in the Senate.</p>	
<a href="#">H.R. 1429</a> <a href="#">Drinking Water Infrastructure for Job Creation Act</a>	<p>Making supplemental appropriations, of \$7,500,000,000, for fiscal year 2019 for the Drinking Water State Revolving Funds, and for other purposes.</p>	<p>Introduced by Rep. Maxine Waters (D-CA) – February 28, 2019</p>	
<a href="#">S. 611</a> <a href="#">Water Affordability, Transparency, Equity, and Reliability Act of 2019</a>	<p>To establish a trust fund, of \$34,850,000,000, to provide for adequate funding for water and sewer infrastructure, and for other purposes.</p>	<p>Introduced by Sen. Bernie Sanders (I-VT) – February 28, 2019</p>	
<a href="#">H.R. 1417</a> <a href="#">Water Affordability, Transparency, Equity, and Reliability Act of 2019</a>	<p>To establish a trust fund, of \$34,850,000,000, to provide for adequate funding for water and sewer infrastructure, and for other purposes.</p>	<p>Introduced by Rep. Brenda Lawrence (D-MI) – March 1, 2019</p>	
<a href="#">H.R. 1497</a> <a href="#">Water Quality Protection and Job Creation Act of 2019</a>	<p>To amend the Federal Water Pollution Control Act to reauthorize certain water pollution control programs, and for other purposes. The legislation would authorize \$120,000,000 for each of fiscal years 2020 through 2024.”</p>	<p>Introduced by Rep. Pete DeFazio (D-OR) – March 6, 2019</p> <p>Reported by the Committee. Placed on the Union Calendar – September 4, 2020</p>	

LEGISLATION	SUMMARY	STATUS	POSITION
<a href="#">H.R. 1621</a> <a href="#">Water Supply Permitting Coordination Act</a>	To authorize the Secretary of the Interior to coordinate Federal and State permitting processes related to the construction of new surface water storage projects on lands under the jurisdiction of the Secretary of the Interior and the Secretary of Agriculture and to designate the Bureau of Reclamation as the lead agency for permit processing, and for other purposes.	Introduced by Rep. Tom McClintock (R-CA) – March 7, 2019	
<a href="#">H.R. 1764</a> <a href="#">To amend the Federal Water Pollution Control Act with respect to permitting terms, and for other purposes.</a>	To extend the NPDES permit period from 5 years to 10 years.	Introduced by Rep. John Garamendi (D-CA) – March 14, 2019	<i>Support (with condition of needing Napolitano's support on the bill as well)</i>
<a href="#">H.R. 2030</a> <a href="#">Colorado River Drought Contingency Plan Authorization Act</a>	This bill requires the Department of the Interior to carry out the Colorado River Drought Contingency Plan which was submitted to Congress on March 19, 2019, by Arizona, California, Colorado, Nevada, New Mexico, Utah, and Wyoming. Interior must execute the plan without delay and operate applicable Colorado River System reservoirs accordingly.	Introduced by Rep. Raul Grijalva (D-AZ) – April 2, 2019  Became Public Law No: 116-14 - April 16, 2019	
<a href="#">S. 1057</a> <a href="#">Colorado River Drought Contingency Plan Authorization Act</a>	This bill requires the Department of the Interior to carry out the Colorado River Drought Contingency Plan which was submitted to Congress on March 19, 2019, by Arizona, California, Colorado, Nevada, New Mexico, Utah, and Wyoming. Interior must execute the plan without delay and operate applicable Colorado River System reservoirs accordingly	Introduced by Sen. Martha McSally (R-AZ) – April 8, 2019  Passed the Senate on April 9, 2019. Introduced in the House	
<a href="#">S. 1087</a> <a href="#">Water Quality Certification Improvement Act of 2019</a>	To amend the Federal Water Pollution Control Act to make changes with respect to water quality certification, and for other purposes.	Introduced by Sen. John Barrasso (R-WY) – April 9, 2019	

LEGISLATION	SUMMARY	STATUS	POSITION
<a href="#">H.R. 2215</a> <a href="#">San Gabriel Mountains Foothills and Rivers Protections Act</a>	<p>The legislation would designate over 30,000 acres of protected wilderness and 45.5 miles of protected rivers and expand the San Gabriel Mountains National Monument, establish a National Recreation Area along the foothills and the San Gabriel Corridor. The bill would expand the borders of the monument to include the western Angeles National Forest</p>	<p>Introduced by Rep. Judy Chu (D-CA) – April 10, 2019</p> <p>Placed on the Union Calendar – February 4, 2020</p>	
<a href="#">S. 1109</a> <a href="#">San Gabriel Mountains Foothills and Rivers Protection Act</a>	<p>To establish as a unit of the National Park System the San Gabriel National Recreation Area in the State of California, and for other purposes.</p>	<p>Introduced by Sen. Kamala Harris (D-CA) – April 10, 2019</p>	
<a href="#">H.R. 2205</a> <a href="#">Water Quality Certification Improvement Act of 2019</a>	<p>To amend the Federal Water Pollution Control Act to make changes with respect to water quality certification, and for other purposes.</p>	<p>Introduced by Rep. David McKinley (R-WV) – April 11, 2019</p>	
<a href="#">H.R. 2287</a> <a href="#">Federal Regulatory Certainty for Water Act</a>	<p>This bill nullifies the Clean Water Rule that was issued on May 27, 2015, by the Environmental Protection Agency and the U.S. Army Corps of Engineers. The rule describes the scope of the Clean Water Act.</p> <p>Under this bill, the Clean Water Act applies to waters of the United States that are (1) navigable-in-fact; or (2) permanent or continuously flowing bodies of water that form geographical features commonly known as streams, oceans, rivers, and lakes that are connected to waters that are navigable-in-fact.</p> <p>Under this bill, the Act does not apply to (1) waters that do not physically abut those waters of the United States through an actual and continuous surface water connection; (2) man-made or natural structures or channels through which water flows intermittently or ephemerally; or (3) wetlands (including playa lakes, prairie potholes, wet meadows, wet prairies, and vernal pools) that lack that continuous surface water connection.</p> <p>The aggregation of wetlands or waters may not be used to determine whether the wetlands or waters are navigable waters.</p>	<p>Introduced by Rep. Mac Thornberry (R-TX) – April 11, 2019</p>	

LEGISLATION	SUMMARY	STATUS	POSITION
<a href="#">H.R. 2313</a> <a href="#">Water Conservation Rebate Tax Parity Act</a>	<p>To amend the Internal Revenue Code of 1986 to expand the exclusion for certain conservation subsidies to include subsidies for water conservation or efficiency measures and storm water management measures.</p>	<p>Introduced by Rep. Jared Huffman (D-CA) – April 12, 2019</p>	
<a href="#">H. Res. 324</a> <a href="#">Recognizing the importance of the United States-Israel economic relationship and encouraging new areas of cooperation</a>	<p>(1) affirms that the United States-Israel economic partnership has achieved great tangible and intangible benefits to both countries and is a foundational component of the strong alliance;</p> <p>(2) recognizes that science and technology innovation present promising new frontiers for United States-Israel economic cooperation, particularly in light of widespread drought, cybersecurity attacks, and other major challenges impacting the United States;</p> <p>(3) encourages the President to regularize and expand existing forums of economic dialogue with Israel and foster both public and private sector participation; and</p> <p>(4) expresses support for the President to explore new agreements with Israel, including in the fields of energy, water, agriculture, medicine, neurotechnology, and cybersecurity.</p>	<p>Introduced by Rep. Ted Lieu (D-CA) – April 18, 2019</p>	
<a href="#">H.R. 2377</a> <a href="#">Protect Drinking Water from PFAS Act of 2019</a>	<p>To amend the Safe Drinking Water Act to require the Administrator of the Environmental Protection Agency to publish a maximum contaminant level goal and promulgate a national primary drinking water regulation for total per- and polyfluoroalkyl substances, and for other purposes.</p>	<p>Introduced by Rep. Brendan Boyle (D-PA) – April 29, 2019</p> <p>Forwarded by Subcommittee to Full Committee on Energy and Commerce by Voice Vote – September 26, 2019</p>	
<a href="#">S. 1251</a> <a href="#">Safe Drinking Water Assistance Act of 2019</a>	<p>A bill to improve and coordinate interagency Federal actions and provide assistance to States for responding to public health challenges posed by emerging contaminants, and for other purposes.</p>	<p>Introduced by Sen. Jeanne Shaheen (D-NH) – April 30, 2019</p>	

LEGISLATION	SUMMARY	STATUS	POSITION
<a href="#">S. 1245</a> <a href="#">All-of-the-Above Federal Building Energy Conservation Act of 2019</a>	A bill to improve energy performance in Federal buildings, including water usage.	Introduced by Sen. John Hoeven (R-ND) – April 30, 2019  Placed on Senate Legislative Calendar - September 25, 2019	
<a href="#">H.R. 2462</a> <a href="#">Flood Mapping Modernization and Homeowner Empowerment Pilot Program Act of 2019</a>	To establish a pilot program to enhance the mapping of urban flooding and associated property damage and the availability of such mapped data to homeowners, businesses, and localities to help understand and mitigate the risk of such flooding, and for other purposes.	Introduced by Rep. Mike Quigley (D-IL) – May 2, 2019	
<a href="#">S. 1276</a> <a href="#">Flood Mapping Modernization and Homeowner Empowerment Pilot Program Act of 2019</a>	To establish a pilot program to enhance the mapping of urban flooding and associated property damage and the availability of such mapped data to homeowners, businesses, and localities to help understand and mitigate the risk of such flooding, and for other purposes.	Introduced by Sen. Dick Durbin (D-IL) – May 2, 2019	
<a href="#">H.R. 2458</a> <a href="#">Water Infrastructure Sustainability and Efficiency Act</a>	To amend the Federal Water Pollution Control Act to require a certain percentage of funds appropriated for revolving fund capitalization grants be used for green projects, and for other purposes.	Introduced by Rep. Debbie Mucarsel-Powell (D-FL) – May 2, 2019	
<a href="#">H.R. 2473</a> <a href="#">Securing Access for the central Valley and Enhancing (SAVE) Water Resources Act</a>	To promote water supply reliability and improved water management for rural communities, the State of California, and the Nation, and for other purposes.	Introduced by Rep. Josh Harder (D-CA) – May 2, 2019  Order to be Reported (Amended) – March 11, 2020	

LEGISLATION	SUMMARY	STATUS	POSITION
<a href="#">H.R. 2470</a> <a href="#">Clean Water Infrastructure Resilience and Sustainability Act</a>	To direct the Administrator of the Environmental Protection Agency to establish a program to make grants to eligible entities to increase the resilience of publicly owned treatment works to natural disasters.	Introduced by Rep. Salud Carbajal (D-CA) – May 3, 2019	
<a href="#">S. 1372</a> <a href="#">PFAS Accountability Act of 2019</a>	To encourage Federal agencies to expeditiously enter into or amend cooperative agreements with States for removal and remedial actions to address PFAS contamination in drinking, surface, and ground water and land surface and subsurface strata, and for other purposes.	Introduced by Sen. Debbie Stabenow (D-MI) – May 8, 2019	
<a href="#">H.R. 2570</a> <a href="#">PFAS User Fee Act of 2019</a>	To ensure that polluters pay ongoing water treatment costs associated with contamination from perfluoroalkyl and polyfluoroalkyl substances, and for other purposes.	Introduced Rep. Harley Rouda (D-CA) – May 9, 2019  Forwarded by Subcommittee to Full Committee on Energy and Commerce by voice vote – September 26, 2019	<i>Watching</i>
<a href="#">H.R. 2665</a> <a href="#">Smart Energy and Water Efficiency Act of 2019</a>	To direct the Secretary of Energy to establish a smart energy and water efficiency program, and for other purposes.	Introduced Rep. Jerry McNerney (D-CA) – May 13, 2019  Ordered to be Reported (Amended) by Voice Vote – July 17, 2019	
<a href="#">H.R. 2705</a> <a href="#">Water Infrastructure Trust Fund Act of 2019</a>	To establish a Water Infrastructure Trust Fund through the Treasury Department - 50% of the fund shall be available to the EPA for capitalization grants under §601 of the Federal Water Pollution Control Act and 50% of the fund shall be available to the EPA for capitalization grants under §1452 under the Safe Drinking Water Act.	Introduced by Rep. Earl Blumenauer (D-OR) – May 14, 2019	



LEGISLATION	SUMMARY	STATUS	POSITION
<a href="#">S. 1473</a> <a href="#">Protect Drinking Water from PFAS Act of 2019</a>	To amend the Safe Drinking Water Act to require the Administrator of the Environmental Protection Agency to set maximum contaminant levels for certain chemicals, and for other purposes.	Introduced by Sen. Kirsten Gillibrand (D-NY) – May 15, 2019	
<a href="#">H.R. 2800</a> <a href="#">PFAS Monitoring Act of 2019</a>	To amend the Safe Drinking Water Act to require continued and expanded monitoring of perfluoroalkyl and polyfluoroalkyl substances in drinking water, and for other purposes.	Introduced by Rep. Elissa Slotkin (D-MI) – May 16, 2019	
<a href="#">S. 1507</a> <a href="#">PFAS Release Disclosure Act</a>	To include certain perfluoroalkyl and polyfluoroalkyl substances in the toxics release inventory, and for other purposes.	Introduced by Sen. Shelley Moore Capito (R-WV) – May 16, 2019  Passed the Senate Committee on Environment and Public Works and placed on the Senate Calendar for a full vote – June 19, 2019	

LEGISLATION	SUMMARY	STATUS	POSITION
<a href="#">H.R. 2776</a> <a href="#">Stop Sewage Overflow Act</a>	<p>To make certain municipalities eligible for grants under the Federal Water Pollution Control Act. Grant cost shares would be applicable as follows:</p> <ul style="list-style-type: none"> <li>• Not less than 55 percent for municipalities the affected residents of which pay, on average, 2.0 percent or less of their household income for sewer service.</li> <li>• Not less than 60 percent for municipalities the affected residents of which pay, on average, more than 2.0 percent, but not more than 2.5 percent, of their household income for sewer service.</li> <li>• Not less than 65 percent for municipalities the affected residents of which pay, on average, more than 2.5 percent, but not more than 3.0 percent, of their household income for sewer service.</li> <li>• Not less than 70 percent for municipalities the affected residents of which pay, on average, more than 3.0 percent, but not more than 3.5 percent, of their household income for sewer service.</li> <li>• Not less than 75 percent for municipalities the affected residents of which pay, on average, more than 3.5 percent of their household income for sewer service.</li> <li>•</li> </ul>	<p>Introduced by Rep. Lori Traham (D-MA) – May 16, 2019</p>	
<a href="#">H.R. 2871</a> <a href="#">Aquifer Recharge Flexibility Act</a>	<p>To provide flexibility to allow greater aquifer recharge. Eligible land, with respect to a Reclamation project, means land that is authorized to receive water under State law and shares a groundwater source with land located in the service area of the Reclamation project.</p>	<p>Introduced by Rep. Russ Fulcher (R-ID) – May 21, 2019</p> <p>Natural Resources Subcommittee on Water, Oceans, and Wildlife hearing held – June 25, 2020</p>	
<a href="#">S. 1604</a> <a href="#">Local Water Protection Act</a>	<p>To amend the Federal Water Pollution Control Act to reauthorize certain programs relating to nonpoint source management – specifically authorization appropriations of \$7,500,000 per year for FY2020 through FY2024.</p>	<p>Introduced by Sen. Amy Klobuchar (D-MN) - May 22, 2019</p>	

LEGISLATION	SUMMARY	STATUS	POSITION
<p><b><a href="#">S. 1689</a></b>  <a href="#">A bill to permit States to transfer certain funds from the clean water revolving fund of a State to the drinking water revolving fund of the State in certain circumstances, and for other purposes.</a></p>	<p>To permit States to transfer certain funds from the clean water revolving fund of a State to the drinking water revolving fund of the State in certain circumstances, and for other purposes.</p>	<p>Introduced by Sen. Cory Booker (D-NJ) – May 23, 2019</p> <p>Became Public Law No: 116-63 – October 4, 2019</p>	<p><i>Watching</i></p>
<p><b><a href="#">S. Res. 213</a></b>  <a href="#">A resolution designating the week of May 19 through May 25, 2019 as “National Public Works Week.”</a></p>	<p>This resolution designates the week of May 19-May 25, 2019, as National Public Works Week.</p>	<p>Introduced by Sen. Jim Inhofe (R-OK) – May 23, 2019</p> <p>Passed the Senate – May 23, 2019</p>	
<p><b><a href="#">S. 1811</a></b>  <a href="#">A bill to make technical corrections to the America’s Water Infrastructure Act of 2018</a></p>	<p>To make technical corrections to the America’s Water Infrastructure Act of 2018. Corrections include:</p> <ul style="list-style-type: none"> <li>• Extending the Non-Federal Implementation Pilot Program from five to ten years; and</li> <li>• Amending the local government reservoir permit review to remove the limitation of those only owned and operated by the Secretary.</li> </ul>	<p>Introduced by Sen. John Barrasso (R-WY)</p> <p>Passed the Senate – July 10, 2019</p>	
<p><b><a href="#">S. 1857</a></b>  <a href="#">Federal Energy and Water Management Performance Act of 2019</a></p>	<p>To amend the National Energy Conservation Policy Act to improve Federal energy and water performance requirements for Federal buildings and establish a Federal Energy Management Program. The program is to exist from 2020-2030. One area addressed is to improve water use efficiency and management, including stormwater management, at facilities of the agency by reducing agency potable water consumption intensity (as measure in galls per gross square food) by 54% by FY2030, relative to the water consumption of the agency in FY2007 and through reductions of 2% each fiscal year.</p>	<p>Introduced by Sen. Lisa Murkowski (R-AK) – June 13, 2019</p> <p>Placed on Senate Legislative Calendar – September 25, 2019</p>	

LEGISLATION	SUMMARY	STATUS	POSITION
<a href="#">H.R. 3254</a> <a href="#">PIPE Act</a>	<p>To require the Administrator of the Environmental Protection Agency to establish a discretionary grant program for drinking water and wastewater infrastructure projects, and for other purposes. Priority of the grant program would be to help bring public water systems into compliance with the Safe Drinking Water Act or for publicly owned treatment works into compliance with the Federal Water Pollution Control Act. The federal cost share of projects under this program will not exceed 100%. The grants program is to be authorized for \$500,000,000 a year for fiscal years 2020 through 2029.</p>	<p>Introduced by Rep. Antonio Delgado (D-NY) – June 14, 2019</p>	
<a href="#">S. 1932</a> <a href="#">Drought Resiliency and Water Supply Infrastructure Act</a>	<p>To support water infrastructure in Reclamation states and for other purposes. The bill includes a 5-year, \$100 million reauthorization of the Bureau of Reclamation’s Title XVI Water Reclamation and Reuse competitive grant program, originally authorized in the 2016 Water Infrastructure Improvements for the Nation (WIIN) Act (Title XVI-WIIN). In addition to the key Title XVI-WIIN Competitive Grant Program, the legislation includes \$60 million for desalination, additional funding for surface and groundwater storage, and a new low-interest loan program for the financing of a range of water infrastructure projects.</p>	<p>Introduced by Sen. Cory Gardner (RCO) – June 20, 2019</p> <p>Subcommittee on Water and Power hearing – July 18, 2019</p>	
<a href="#">H.R. 3423</a> <a href="#">National Green Bank Act of 2019</a>	<p>To amend title 31, United States Code, to provide for the issuance of Green Bonds and to establish the United States Green Bank, and for other purposes.</p>	<p>Introduced by Rep. Jim Himes (D-CT) – June 21, 2019</p>	
<a href="#">H.R. 3521</a> <a href="#">Wastewater Infrastructure Workforce Investment Act</a>	<p>To amend the Federal Water Pollution Control Act with respect to wastewater infrastructure workforce development, and for other purposes. Amends the language from manpower to workforce. Gives the states the ability to reserve up to 1% of the sums allotted to the state under this section for the fiscal year to carry out workforce development, training, and retraining.</p>	<p>Introduced Rep. Greg Stanton (D-AZ) – June 26, 2019</p>	
<a href="#">H.R. 3510</a> <a href="#">Water Resources Research Amendments Act</a>	<p>To amend the Water Resources Research Act of 1984 to reauthorize grants for and require applied water supply research regarding the water resources research and technology institutes established under that Act.</p>	<p>Introduced by Rep. Josh Harder (D-CA) – June 26, 2019</p> <p>Subcommittee on Water, Oceans, and Wildlife hearing – July 25, 2019</p>	

LEGISLATION	SUMMARY	STATUS	POSITION
<a href="#">S. 2044</a> <a href="#">Water Supply Infrastructure Rehabilitation and Utilization Act</a>	To amend the Omnibus Public Land Management Act of 2009 to establish an Aging Infrastructure Account, to amend the Reclamation Safety of Dams Act of 1978 to provide additional funds under that Act, to establish a review of flood control rule curves pilot project within the Bureau of Reclamation, and for other purposes.	Introduced by Sen. Martha McSally (R-AZ) – June 27, 2019  Placed on Senate Legislative Calendar – October 29, 2019	
<a href="#">S. 2013</a> <a href="#">A bill to protect the right of individuals to bear arms at water resources development projects</a>	To protect the right of individuals to bear arms at water resources development projects.	Introduced by Sen. Mike Crapo (R-ID) – June 27, 2019	<i>Watching</i>
<a href="#">H.R. 3616</a> <a href="#">Clean Water Standards for PFAS Act of 2019</a>	To require the Administrator of the Environmental Protection Agency to designate per- and polyfluoroalkyl substances as toxic pollutants under the Federal Water Pollution Control Act, and for other purposes.	Introduced by Rep. Chris Pappas (D-NH) – July 2, 2019	
<a href="#">S. 2056</a> <a href="#">Build America, Buy America Act</a>	To ensure that certain Federal infrastructure programs require the use of materials produced in the United States, and for other purposes.	Introduced by Sen. Sherrod Brown (D-OH) – July 8, 2019	
<a href="#">H.R. 3723</a> <a href="#">Desalination Development Act</a>	To promote desalination project development and drought resilience, and for other purposes.	Introduced by Rep. Mike Levin (D-CA) – July 11, 2019  Ordered to be Reported (Amended) – March 11, 2020	

LEGISLATION	SUMMARY	STATUS	POSITION
<a href="#">H.R. 3779</a> <a href="#">Resilience</a> <a href="#">Revolving Loan</a> <a href="#">Fund Act of 2019</a>	<p>To amend the Robert T. Stafford Disaster Relief and Emergency Assistance Act to allow the Administrator of the Federal Emergency Management Agency to provide capitalization grants to eligible entities to establish revolving funds to provide assistance to reduce disaster risks, and for other purposes.</p>	<p>Introduced by Rep. Angie Craig (D-MN) – July 16, 2019</p> <p>Ordered to be Reported (Amended) by Voice Vote – September 19, 2019</p>	
<a href="#">H.R. 3844</a> <a href="#">Farmer Fairness Act</a>	<p>To amend the Federal Water Pollution Control Act to require all persons exercising substantial operational control over a concentrated animal feeding operation to jointly obtain a permit for certain discharges, and for other purposes.</p>	<p>Introduced by Rep. Ro Khanna (D-CA) – July 18, 2019</p>	
<a href="#">S. 2187</a> <a href="#">National Flood</a> <a href="#">Insurance Program</a> <a href="#">Reauthorization and</a> <a href="#">Reform Act of 2019</a>	<p>To reauthorize the National Flood Insurance Program, and for other purposes.</p>	<p>Introduced by Sen. Robert Menendez (D-NJ) – July 18, 2019</p>	
<a href="#">S. 2164</a> <a href="#">Water Resources</a> <a href="#">Research</a> <a href="#">Amendments</a> <a href="#">Act</a>	<p>To amend the Water Resources Research Act of 1984 to reauthorize grants for and require applied water supply research regarding the water resources research and technology institutes established under that Act.</p>	<p>Introduced by Sen. Ben Cardin (D-MD) – July 18, 2019</p>	
<a href="#">S. 2239</a> <a href="#">A bill to codify an</a> <a href="#">Executive order</a> <a href="#">preparing the United</a> <a href="#">States for the</a> <a href="#">impacts of climate</a> <a href="#">change, and for other</a> <a href="#">purposes</a>	<p>To codify an Executive order preparing the United States for the impacts of climate change, and for other purposes.</p>	<p>Introduced by Sen. Amy Klobuchar (D-MN) – July 23, 2019</p>	

LEGISLATION	SUMMARY	STATUS	POSITION
<a href="#"><u>H.R. 3944</u></a> <a href="#"><u>To amend the Water Resources Reform and Development Act of 2014 to modify the procedure for communicating certain emergency risks, and for other purposes.</u></a>	To amend the Water Resources Reform and Development Act of 2014 to modify the procedure for communicating certain emergency risks, and for other purposes.	Introduced by Rep. Kevin Hern (R-OK) – July 24, 2019	
<a href="#"><u>H.R. 3949</u></a> <a href="#"><u>Safe Drinking Water in Playgrounds and Parks Act</u></a>	To amend the Safe Drinking Water Act to provide for drinking water fountain replacement in playgrounds and parks, and for other purposes.	Introduced by Rep. Grace Meng (D-NY) – July 24, 2019	
<a href="#"><u>H.R. 4050</u></a> <a href="#"><u>ZERO WASTE Act</u></a>	To direct the Administrator of the Environmental Protection Agency to award grants for projects that are consistent with zero-waste practices, and for other purposes.	Introduced by Rep. Ilhan Omar (D-MN) – July 25, 2019	
<a href="#"><u>H.R. 4033</u></a> <a href="#"><u>Water Justice Act</u></a>	To provide supplemental appropriations for safe and secure water, and for other purposes.	Introduced by Rep. Daniel Kildee (D-MI) – July 25, 2019	
<a href="#"><u>H.R. 4006</u></a> <a href="#"><u>CLEANER Act of 2019</u></a>	To require regulation of wastes associated with the exploration, development, or production of crude oil, natural gas, or geothermal energy under the Solid Waste Disposal Act, and for other purposes.	Introduced by Rep. Matt Cartwright (D-PA) – July 26, 2019	
<a href="#"><u>H.R. 4007</u></a> <a href="#"><u>Focused Reduction of Effluence and Stormwater runoff through HydroEnvironmental Regulation Act of 2019</u></a>	To amend the Federal Water Pollution Control Act and direct the Secretary of the Interior to conduct a study with respect to stormwater runoff from oil and gas operations, and for other purposes.	Introduced by Rep. Matt Cartwright (D-PA) – July 26, 2019	

LEGISLATION	SUMMARY	STATUS	POSITION
<a href="#">S. 2325</a> <a href="#">Super Pollutants Act</a>	To establish a task force to review policies and measures to promote, and to develop best practices for, reduction of short-lived climate pollutants, and for other purposes.	Introduced by Sen. Murphy (D-CT) – July 30, 2019  Placed on Senate Legislative Calendar – November 7, 2019	
<a href="#">S. 2356</a> <a href="#">Define WOTUS Act of 2019</a>	To provide a definition of navigable waters, and for other purposes.	Introduced by Mike Braun (R-IN) – July 31, 2019	
<a href="#">S. 2353</a> <a href="#">Protecting Firefighters from Adverse Substances Act of 2019</a>	To direct the Administrator of the Federal Emergency Management Agency to develop guidance for firefighters and other emergency response personnel on best practices to protect them from exposure to PFAS and to limit and prevent the release of PFAS into the environment, and for other purposes.	Introduced by Sen. Gary Peters (D-MI) – July 31, 2019  Placed on Senate Legislative Calendar – February 3, 2020	
<a href="#">S. 2410</a> <a href="#">Flood Reduction, Wildlife Habitat, and Water Quality Improvement Act of 2019</a>	To amend the Federal Water Pollution Control Act to modify the requirements for permits for dredged or fill material, and for other purposes.	Introduced by Sen. Cindy Hyde-Smith (R-MS) – July 31, 2019	
<a href="#">S. 2404</a> <a href="#">Build Local, Hire Local Act</a>	To establish an expansive infrastructure program to create local jobs and raise the quality of life in every community, to launch middle class career pathways in infrastructure, and to invest in high-quality American jobs, and for other purposes.	Introduced by Sen. Kirsten Gillibrand (D-NY) – July 31, 2019	



LEGISLATION	SUMMARY	STATUS	POSITION
<a href="#"><u>H.R. 4143</u></a> <a href="#"><u>Super Pollutants Act of 2019</u></a>	To establish a task force to review policies and measures to promote, and to develop best practices for, reduction of short-lived climate pollutants, and for other purposes.	Introduced by Rep. Scott Peters (D-CA) – August 2, 2019	
<a href="#"><u>H.R. 4149</u></a> <a href="#"><u>REGION Act</u></a>	To prohibit the closure, consolidation, or elimination of offices of the Environmental Protection Agency.	Introduced by Rep. Debbie Dingell (D-MI) – August 2, 2019	
<a href="#"><u>H.R. 4205</u></a> <a href="#"><u>FLARE Act</u></a>	To require the Secretary of Agriculture to reimburse sponsors for certain costs of emergency water protection measures, and for other purposes.	Introduced by Rep. John Curtis (R-UT) – August 23, 2019	
<a href="#"><u>H.R. 4266</u></a> <a href="#"><u>Clean Water Through Green Infrastructure Act</u></a>	To establish centers of excellence for innovative stormwater control infrastructure, and for other purposes.	Introduced by Rep. Denny Heck (D-WA) – September 10, 2019	
<a href="#"><u>S. 2456</u></a> <a href="#"><u>Clean Water Through Green Infrastructure Act</u></a>	To establish centers of excellence for innovative stormwater control infrastructure, and for other purposes.	Introduced by Sen. Tom Udall (R-NM) – September 10, 2019	
<a href="#"><u>S. 2466</u></a> <a href="#"><u>Water Justice Act</u></a>	To provide supplemental appropriations for safe and secure water, and for other purposes.	Introduced by Sen. Kamala Harris (D-CA) – September 11, 2019	
<a href="#"><u>S. 2470</u></a> <a href="#"><u>Energy and Water Development and Related Agencies Appropriations Act, 2020</u></a>	Making appropriations for energy and water development and related agencies for the fiscal year ending September 30, 2020, and for other purposes.	Introduced by Sen. Lamar Alexander (R-TN) – September 12, 2019  Placed on Senate Legislative Calendar – September 12, 2019	

LEGISLATION	SUMMARY	STATUS	POSITION
<a href="#"><u>H.R. 4321</u></a> <a href="#"><u>GET THE LEAD OUT Act of 2019</u></a>	To eliminate lead-based pipe and tap hazards in housing, and for other purposes.	Introduced by Rep. Tim Ryan (D-OH) – September 12, 2019	
<a href="#"><u>H.R. 4341</u></a> <a href="#"><u>Critically Endangered Animals Conservation Act of 2019</u></a>	To assist in the conservation of critically endangered species in foreign countries, and for other purposes.	Introduced by Rep. Jarred Huffman (D-CA) – September 12, 2019  Subcommittee on Water, Oceans, and Wildlife hearing - September 24, 2019	
<a href="#"><u>H.R. 4347</u></a> <a href="#"><u>PREPARE Act of 2019</u></a>	To enhance the Federal Government’s planning and preparation for extreme weather and the Federal Government’s dissemination of best practices to respond to extreme weather, thereby increasing resilience, improving regional coordination, and mitigating the financial risk to the Federal Government from such extreme weather, and for other purposes.	Introduced by Rep. Matt Cartwright (D-PA) – September 17, 2019  Ordered to be Reported by voice vote – September 19, 2019	
<a href="#"><u>S. 2491</u></a> <a href="#"><u>Protect America's Wildlife and Fish in Need of Conservation Act of 2019</u></a>	To terminate certain rules issued by the Secretary of the Interior and the Secretary of Commerce relating to endangered and threatened species, and for other purposes.	Introduced by Sen. Tom Udall (D-NM) – September 17, 2019	

LEGISLATION	SUMMARY	STATUS	POSITION
<a href="#"><u>S. 2522</u></a> <a href="#"><u>Agriculture, Rural Development, Food and Drug Administration, and Related Agencies Appropriations Act, 2020</u></a>	Making appropriations for Agriculture, Rural Development, Food and Drug Administration, and Related Agencies for the fiscal year ending September 30, 2020, and for other purposes.	Introduced by Rep. John Hoeven (R-ND) – September 19, 2019  Placed on Senate Legislative Calendar – September 19, 2019	
<a href="#"><u>H.R. 4348</u></a> <a href="#"><u>PAW and FIN Conservation Act of 2019</u></a>	To terminate certain rules issued by the Secretary of the Interior and the Secretary of Commerce relating to endangered and threatened species, and for other purposes.	Introduced by Rep. Raul Grijalva (D-AZ) – September 24, 2019  Placed on the Union Calendar – August 7, 2020	
<a href="#"><u>S.Res. 324</u></a> <a href="#"><u>A resolution designating September 29, 2019, as "National Urban Wildlife Refuge Day"</u></a>	Designating September 29, 2019, as “National Urban Wildlife Refuge Day”.	Introduced by Sen. Cory Gardner (R-CO) – September 24, 2019  Resolution agreed to in Senate without amendment and with a preamble by Unanimous Consent – October 16, 2019	
<a href="#"><u>H.R. 4483</u></a> <a href="#"><u>Localizing Authority of Management Plans Act of 2019</u></a>	To amend the Endangered Species Act of 1973 to increase State and local involvement in management plans.	Introduced by Rep. Don Young (R-AK) – September 24, 2019	

LEGISLATION	SUMMARY	STATUS	POSITION
<a href="#">S. 2580</a> <a href="#">Department of the Interior, Environment, and Related Agencies Appropriations Act, 2020</a>	Making appropriations for the Department of the Interior, environment, and related agencies for the fiscal year ending September 30, 2020, and for other purposes.	Introduced by Sen. Lisa Murkowski (R-AK) – September 26, 2019  Placed on Senate Legislative Calendar – September 26, 2019	
<a href="#">H.R. 4512</a> <a href="#">Outdoors for All Act</a>	To provide grants for projects to acquire land and water for parks and other outdoor recreation purposes and to develop new or renovate existing outdoor recreation facilities.	Introduced by Rep. Nanette Diaz Barragan (D-CA) – September 26, 2019  Subcommittee on Natural Parks, Forests, and Public Lands hearing – February 27, 2020	
<a href="#">H.R. 4416</a> <a href="#">Lead-Free Future Act of 2019</a>	To authorize the Secretary of Housing and Urban Development to award grants to eligible entities to evaluate and reduce lead-based paint hazards, lead in drinking water hazards, and lead in soil hazards in pre-1978 residential real properties.	Introduced by Rep. Jared Golden (D-ME) – October 2, 2019	
<a href="#">H.R. 4659</a> <a href="#">Water Supply Infrastructure Rehabilitation and Utilization Act</a>	To amend the Omnibus Public Land Management Act of 2009 to establish an Aging Infrastructure Account, to amend the Reclamation Safety of Dams Act of 1978 to provide additional funds under that Act, to establish a review of flood control rule curves pilot project within the Bureau of Reclamation, and for other purposes.	Introduced by Rep. Newhouse (R-WA) – October 11, 2019	
<a href="#">S. 2596</a> <a href="#">Voluntary Water Partnership for Distressed Communities Act of 2019</a>	To amend the Safe Drinking Water Act to authorize certain community water systems to enter into partnerships to improve the water systems, and for other purposes.	Introduced by Sen. Tammy Duckworth (D-IL) – October 15, 2019	

\\

LEGISLATION	SUMMARY	STATUS	POSITION
<a href="#"><u>H.Res. 628</u></a> <a href="#"><u>Expressing support for the designation of the week beginning on October 13, 2019, as National Wildlife Refuge Week</u></a>	Expressing support for the designation of the week beginning on October 13, 2019, as National Wildlife Refuge Week.	Introduced by Rep. Mike Thompson (D-CA) – October 15, 2019	
<a href="#"><u>S.Res. 362</u></a> <a href="#"><u>A resolution designating the week beginning on October 13, 2019, as "National Wildlife Refuge Week"</u></a>	Designating the week beginning on October 13, 2019, as “National Wildlife Refuge Week”.	Introduced by Sen. Chris Coons (D-DE) – October 17, 2019  Resolution agreed to in Senate without amendment and with a preamble by Unanimous Consent – October 24, 2019	
<a href="#"><u>S. 2636</u></a> <a href="#"><u>Clean Water Infrastructure Resilience and Sustainability Act</u></a>	To amend the Federal Water Pollution Control Act to establish a program to make grants to eligible entities to increase the resilience of publicly owned treatment works to natural hazards, and for other purposes.	Introduced by Sen. Benjamin Cardin (D-MD) – October 17, 2019	
<a href="#"><u>H.R. 4723</u></a> <a href="#"><u>Fish Act of 2019</u></a>	To require the identification of salmon conservation areas, and for other purposes.	Introduced by Rep. Jared Huffman (D-CA) – October 17, 2019  Subcommittee on Water, Oceans, and Wildlife hearing – January 14, 2020	

LEGISLATION	SUMMARY	STATUS	POSITION
<p><b><a href="#">H.R. 4732</a></b>  <a href="#">To establish a Global Climate Change Resilience Strategy, to authorize the admission of climate-displaced persons, and for other purposes</a></p>	<p>To establish a Global Climate Change Resilience Strategy, to authorize the admission of climate-displaced persons, and for other purposes.</p>	<p>Introduced by Rep. Nydia Velasquez (D-NY) – October 17, 2019</p>	
<p><b><a href="#">S.Res. 372</a></b>  <a href="#">A resolution expressing the sense of the Senate that the Federal Government should establish a national goal of conserving at least 30 percent of the land and ocean of the United States by 2030</a></p>	<p>Expressing the sense of the Senate that the Federal Government should establish a national goal of conserving at least 30 percent of the land and ocean of the United States by 2030.</p>	<p>Introduced by Sen. Tom Udall (D-NM) – October 22, 2019</p>	
<p><b><a href="#">H.R. 4780</a></b>  <a href="#">National Infrastructure Investment Corporation Act of 2019</a></p>	<p>To establish a Government corporation to provide loans and loan guarantees for infrastructure projects, and for other purposes.</p>	<p>Introduced by Rep. Salud Carbajal (D-CA) – October 22, 2019</p>	
<p><b><a href="#">S. 2674</a></b>  <a href="#">Assuring Quality Water Infrastructure Act</a></p>	<p>To amend the Safe Drinking Water Act to establish a grant program for improving infrastructure asset management by small public water systems, and for other purposes.</p>	<p>Introduced by Sen. Shelley Capito (R-WV) – October 23, 2019</p>	

LEGISLATION	SUMMARY	STATUS	POSITION
<a href="#">S. 2687</a> <a href="#">Low-Income Water Customer Assistance Programs Act of 2019</a>	To amend the Safe Drinking Water Act and the Federal Water Pollution Control Act to establish pilot programs to assist low-income households in maintaining access to sanitation services and drinking water, and for other purposes.	Introduced by Sen. Benjamin Cardin (D-MD) – October 23, 2019	
<a href="#">H.R. 4832</a> <a href="#">Low-Income Water Customer Assistance Programs Act of 2019</a>	To amend the Safe Drinking Water Act and the Federal Water Pollution Control Act to establish pilot programs to assist low-income households in maintaining access to sanitation services and drinking water, and for other purposes.	Introduced by Rep. Marcia Judge (D-OH) – October 23, 2019	
<a href="#">H.R. 4891</a> <a href="#">Western Water Security Act of 2019</a>	To provide for the conduct of certain water security measures in the Western United States, and for other purposes.	Introduced by Rep. Xochitl Torres Small (D-NM) – October 28, 2019  Ordered to be Reported (Amended) – March 11, 2020	
<a href="#">S. 2767</a> <a href="#">A bill to amend the Federal Water Pollution Control Act to establish a pilot competitive grant program for improving the sharing of water quality data, and for other purposes</a>	To amend the Federal Water Pollution Control Act to establish a pilot competitive grant program for improving the sharing of water quality data, and for other purposes.	Introduced by Sen. Doug Jones (D-AL) – October 31, 2019	
<a href="#">S. 2783</a> <a href="#">Responsibly Enhancing America's Landscapes Act</a>	To amend title 54, United States Code, to establish, fund, and provide for the use of amounts in a National Park Service Legacy Restoration Fund to address the maintenance backlog of the National Park Service, and for other purposes.	Introduced by Sen. Michael Enzi (R-WY) – November 5, 2019	

LEGISLATION	SUMMARY	STATUS	POSITION
<a href="#"><u>S. 2799</u></a> <a href="#"><u>Nexus of Energy and Water for Sustainability Act of 2019</u></a>	To require the Secretary of Energy and the Secretary of the Interior to establish a joint Nexus of Energy and Water Sustainability Office, and for other purposes.	Introduced by Sen. Lisa Murkowski (R-AK) –November 6, 2019  Sen. Murkowski from Committee on Energy and Natural Resources filed written report – January 7, 2020	
<a href="#"><u>S. 2792</u></a> <a href="#"><u>Penny Plan to Enhance Infrastructure Act of 2019</u></a>	To amend the Balanced Budget and Emergency Deficit Control Act of 1985 to establish a discretionary spending limit for infrastructure spending.	Introduced by Sen. Rand Paul (R-KY) – November 6, 2019	
<a href="#"><u>S. 2862</u></a> <a href="#"><u>Drought Relief through Innovative Projects Act of 2019</u></a>	To direct the Secretary of Agriculture to establish a grant program to remove nonnative plant species that contribute to drought conditions, and for other purposes.	Introduced by Sen. Krysten Sinema (D-AZ)-November 14, 2019	
<a href="#"><u>H.R. 5095</u></a> <a href="#"><u>Endangered Species Accountability Reform Act</u></a>	To require the Secretary of the Interior to delist certain endangered species and threatened species.	Introduced by Rep.Rep. Blaine Luetkemeyer (R-MO) – November 14, 2019	
<a href="#"><u>H.R. 5120</u></a> <a href="#"><u>SAFER Pipelines Act of 2019</u></a>	To amend title 49, United States Code, to provide enhanced safety and environmental protection in pipeline transportation, and for other purposes.	Introduced by Rep. Peter DeFazio (D-OR) – November 20, 2019  Ordered to be Reported (Amended) – November 20, 2019	



LEGISLATION	SUMMARY	STATUS	POSITION
<a href="#"><u>H.R. 5176</u></a> <a href="#"><u>Climate Resiliency Service Corps Act of 2019</u></a>	To amend the National and Community Service Act of 1990 to establish a climate resiliency service corps to help communities withstand and respond to changes in the Earth’s climate with respect to natural disasters, and for other purposes.	Introduced by Rep. Judy Chu (D-CA) – November 19, 2019	
<a href="#"><u>H.R. 5193</u></a> <a href="#"><u>Buy America for Drinking Water Extension Act of 2019</u></a>	To amend the Safe Drinking Water Act to extend and expand the provision requiring the use of iron and steel products that are produced in the United States in projects funded through a State drinking water treatment revolving loan fund.	Introduced by Rep. Cheri Bustos (D-IL) – November 20, 2019	
<a href="#"><u>H.R. 5217</u></a> <a href="#"><u>WOW Act</u></a>	To provide for western water security, reliability, modernization, and abundance, and for other purposes.	Introduced by Rep. Tom McClintock (R-CA) – November 21, 2019	
<a href="#"><u>H.R. 5288</u></a> <a href="#"><u>Upper Mississippi River Flood Control Act</u></a>	To amend the Water Resources Development Act of 1999 to direct the Secretary of the Army to develop a plan to address water resource problems in the Upper Mississippi River Basin, and for other purposes.	Introduced by Rep. Blaine Luetkemeyer (R-MO) – December 3, 2019	
<a href="#"><u>S. 2978</u></a> <a href="#"><u>Energy and Water Research Integration Act of 2019</u></a>	To ensure consideration of water intensity in the Department of Energy’s energy research, development, and demonstration programs to help guarantee efficient, reliable, and sustainable delivery of energy and clean water resources.	Introduced by Sen. Catherine Cortez Masto (D-NV) – December 4, 2019	
<a href="#"><u>S. 2980</u></a> <a href="#"><u>Clean Water Standards for PFAS Act of 2019</u></a>	To require the promulgation of certain standards for perfluoroalkyl and polyfluoroalkyl substances under the Federal Water Pollution Control Act, and for other purposes.	Introduced by Sen. Kirsten Gillibrand (D-NY) – December 4, 2019	
<a href="#"><u>H.R. 5302</u></a> <a href="#"><u>Western Water Recycling and Drought Relief Act</u></a>	To amend the Reclamation Wastewater and Groundwater Study and Facilities Act to authorize certain recycled water projects, and for other purposes.	Introduced by Rep. Jerry McNerney (D-CA) – December 4, 2019	
<a href="#"><u>H.R. 5303</u></a> <a href="#"><u>California Central Coast Conservation Act</u></a>	To establish a moratorium on oil and gas leasing on public land on the Central Coast of California.	Introduced by Rep. Jimmy Panetta (D-CA) – December 4, 2019	

LEGISLATION	SUMMARY	STATUS	POSITION
<a href="#">H.R. 5316</a> <a href="#">Move Water Now Act</a>	To provide for the restoration of the original carrying capacity of canals impacted by land subsidence, and for other purposes.	Introduced by Rep. TJ Cox (D-CA) – December 5, 2019  Ordered to be Reported – February 12, 2020	
<a href="#">H.R. 5347</a> <a href="#">Disadvantaged Community Drinking Water Assistance Act</a>	To require the Secretary of the Interior to establish a grant program to close gaps in access to safe drinking water in disadvantaged communities, and for other purposes.	Introduced by Rep. TJ Cox (D-CA) – December 6, 2019  Ordered to be Reported (Amended) – February 12, 2020	
<a href="#">H.R. 5361</a> <a href="#">Safe Drinking Water Assistance Act of 2019</a>	To improve and coordinate interagency Federal actions and provide assistance to States for responding to public health challenges posed by emerging contaminants, and for other purposes.	Introduced by Rep. Lisa Blunt Rochester (D-DE) – December 9, 2019	
<a href="#">S. 3044</a> <a href="#">Western Tribal Water Infrastructure Act of 2019</a>	To amend the America's Water Infrastructure Act of 2018 to expand the Indian reservation drinking water program, and for other purposes.	Introduced by Sen. Ron Wyden (D-OR) – December 12, 2019  Ordered to be reported with an amendment – July 29, 2020	
<a href="#">S. 3046</a> <a href="#">Wastewater Efficiency and Treatment Act of 2019</a>	To amend the Energy Policy Act of 2005 to establish a program to provide grants and loan guarantees to improve the energy efficiency of publicly owned wastewater treatment facilities, and for other purposes.	Introduced by Sen. Jeff Merkley (D-OR) – December 12, 2019	

LEGISLATION	SUMMARY	STATUS	POSITION
<a href="#">S. 3051</a> <a href="#">America's</a> <a href="#">Conservation</a> <a href="#">Enhancement Act</a>	To improve protections for wildlife, and for other purposes.	<p>Introduced by John Barrasso (R-WY) – December 12, 2019</p> <p>Sen. Barrasso filed written report – July 1, 2020</p>	
<a href="#">H.R. 5430</a> <a href="#">United States-</a> <a href="#">Mexico-Canada</a> <a href="#">Agreement</a> <a href="#">Implementation Act</a>	To implement the Agreement between the United States of America, the United Mexican States, and Canada attached as an Annex to the Protocol Replacing the North American Free Trade Agreement.	<p>Introduced by Rep. Steny Hoyer (D-MD) December 13, 2019</p> <p>Became Public Law No: 116-113 – January 29, 2020</p>	
<a href="#">S. 3052</a> <a href="#">United States-</a> <a href="#">Mexico-Canada</a> <a href="#">Agreement</a> <a href="#">Implementation Act</a>	To implement the Agreement between the United States of America, the United Mexican States, and Canada attached as an Annex to the Protocol Replacing the North American Free Trade Agreement.	Introduced by Sen. Chuck Grassley (R-IA) – December 16, 2019	
<a href="#">H.R. 5435</a> <a href="#">American Public</a> <a href="#">Lands and Waters</a> <a href="#">Climate Solution Act</a> <a href="#">of 2019</a>	To require the Secretary of the Interior and the Chief of the United States Forest Service to meet certain targets for the reduction of the emission of greenhouse gases, and for other purposes.	<p>Introduced by Rep. Raul Grijalva (D-AZ) – December 16, 2019</p> <p>Committee on Natural Resources hearing – February 26, 2020</p>	
<a href="#">H.R. 5445</a> <a href="#">Critical</a> <a href="#">Infrastructure Act of</a> <a href="#">2019</a>	To amend the Endangered Species Act of 1973 to encourage the construction of critical infrastructure, and for other purposes.	Introduced by Rep. Chris Stewart (R-UT) – December 17, 2019	

LEGISLATION	SUMMARY	STATUS	POSITION
<a href="#">S. 3082</a> <a href="#">LEVEE Act</a>	To establish a program to establish permanent features for flood control in areas in which temporary features have been constructed, and for other purposes.	Introduced by Sen. Kirsten Gillibrand (D-NY) – December 18, 2019	
<a href="#">H.R.5513</a> <a href="#">Affordable Safe Drinking Water Act of 2019</a>	To amend the Federal Water Pollution Control Act and the Safe Drinking Water Act to modify the payment periods of loans from State revolving funds under those Acts, and for other purposes.	Introduced by Rep. Joseph Kennedy (D-MA) – December 20, 2019	
<a href="#">H.R. 5504</a> <a href="#">To amend the National Dam Safety Program Act with respect to the definition of eligible high hazard potential dam, and for other purposes</a>	To amend the National Dam Safety Program Act with respect to the definition of eligible high hazard potential dam, and for other purposes.	Introduced by Rep. Julia Brownley (D-CA) – December 19, 2019	
<a href="#">H.R.5539</a> <a href="#">Clean Water Standards for PFAS Act of 2020</a>	To require the Administrator of the Environmental Protection Agency to review and develop effluent standards, pretreatment standards, and water quality criteria for PFAS under the Federal Water Pollution Control Act, to provide Federal grants to publicly owned treatment works to implement standards, and for other purposes.	Introduced by Rep. Chris Pappas (D-NH) – January 3, 2020	
<a href="#">H.R. 5540</a> <a href="#">PFAS Transparency Act</a>	To require, pursuant to the Federal Water Pollution Control Act, disclosure of the introduction of perfluoroalkyl or polyfluoroalkyl substances into treatment works, and for other purposes.	Introduced by Rep. Antonio Delgado (D-NY) – January 3, 2020	
<a href="#">S. 3160</a> <a href="#">Affordable Safe Drinking Water Act of 2020</a>	To amend the Federal Water Pollution Control Act and the Safe Drinking Water Act to modify the payment periods of loans from State revolving funds under those Acts, and for other purposes.	Introduced by Sen. Elizabeth Warren (D-MA) – January 8, 2020	
<a href="#">S. 3171</a> <a href="#">Protect and Restore America's Estuaries Act</a>	To amend the Federal Water Pollution Control Act to reauthorize the National Estuary Program, and for other purposes.	Introduced by Se. Whitehouse (D-RI) – January 9, 2020	

LEGISLATION	SUMMARY	STATUS	POSITION
<a href="#">S. 3176</a> <a href="#">United States-Israel Security Assistance Authorization Act of 2020</a>	To amend the Foreign Assistance Act of 1961 and the United States-Israel Strategic Partnership Act of 2014 to make improvements to certain defense and security assistance provisions and to authorize the appropriations of funds to Israel, and for other purposes.	Introduced by Sen. Marco Rubio (R-FL) – January 9, 2020  Placed on Senate Legislation Calendar – June 3, 2020	
<a href="#">H.R. 5579</a> <a href="#">LIST Act of 2020</a>	To amend the Endangered Species Act of 1973 to provide for improved precision in the listing, delisting, and downlisting of endangered species and potentially endangered species.	Introduced by Rep. Greg Gianforte (R-MT) – January 10, 2020	
<a href="#">H.R. 5580</a> <a href="#">Bring ESA Into the 21st Century Act</a>	To codify certain rules issued by the Secretary of the Interior and the Secretary of Commerce relating to endangered species and threatened species, and for other purposes.	Introduced by Rep. Paul Gosar (R-AZ) – January 10, 2020	
<a href="#">H.R. 5588</a> <a href="#">WHOLE Act of 2020</a>	To amend the Endangered Species Act of 1973 to provide for consideration of the totality of conservation measures in determining the impact of proposed Federal agency action.	Introduced by Rep. Dan Newhouse (R-WA) – January 13, 2020	
<a href="#">H.R. 5585</a> <a href="#">Listing Reform Act</a>	To amend the Endangered Species Act of 1973 to require review of the economic cost of adding a species to the list of endangered species or threatened species, and for other purposes.	Introduced by Rep. Pete Olson (R-TX) – January 13, 2020	
<a href="#">H.R. 5591</a> <a href="#">Critical Habitat Improvement Act</a>	To amend the Endangered Species Act of 1973 to add requirements to the designation of areas as critical habitats, and for other purposes.	Introduced by Rep. Mike Johnson (R-LA) – January 13, 2020	
<a href="#">H.R. 5594</a> <a href="#">EMPOWERS Act of 2020</a>	To provide for greater county and State consultation with regard to petitions under the Endangered Species Act of 1973, and for other purposes.	Introduced by Rep. Jason Smith (R-MO) – January 13, 2020	
<a href="#">H.R. 5595</a> <a href="#">Israel Anti-Boycott Act</a>	To impose additional prohibitions relating to foreign boycotts under Export Control Reform Act of 2018, and for other purposes.	Introduced by Rep. Lee Zeldin (R-NY) – January 13, 2020	
<a href="#">H.R. 5601</a> <a href="#">Property Rights Protection Act of 2020</a>	To protect private property rights, and for other purposes.	Introduced by Rep. Ralph Norman (R-SC) – January 14, 2020	

LEGISLATION	SUMMARY	STATUS	POSITION
<a href="#"><u>H.Res. 797</u></a> <a href="#"><u>Encouraging the Environmental Protection Agency to maintain and strengthen requirements under the Clean Water Act and reverse ongoing administrative actions to weaken this landmark law and protections for United States waters</u></a>	<p>Encouraging the Environmental Protection Agency to maintain and strengthen requirements under the Clean Water Act and reverse ongoing administrative actions to weaken this landmark law and protections for United States waters.</p>	<p>Introduced by Rep. Debbie Dingell (D-MI) – January 14, 2020</p>	
<a href="#"><u>H.R. 5598</u></a> <a href="#"><u>Boundary Waters Wilderness Protection and Pollution Prevention Act</u></a>	<p>To provide for the protection of the Boundary Waters Canoe Area Wilderness and interconnected Federal lands and waters, including Voyageurs National Park, within the Rainy River Watershed in the State of Minnesota, and for other purposes.</p>	<p>Introduced by Rep. Betty McCollum (D-MN) – January 14, 2020</p> <p>Subcommittee on Energy and Mineral Resources hearing – February 5, 2020</p>	
<a href="#"><u>H.R. 5606</u></a> <a href="#"><u>Desert National Wildlife Refuge and Nevada Test and Training Range Withdrawal and Management Act</u></a>	<p>To extend the withdrawal and reservation of certain public land in the State of Nevada for the continued use of the Nevada test and training range, to designate certain land in the Desert National Wildlife Refuge as wilderness, and for other purposes.</p>	<p>Introduced by Rep. Steven Horsford (D-NV) – January 15, 2020</p>	
<a href="#"><u>H.R. 5615</u></a> <a href="#"><u>TREES Act</u></a>	<p>To establish a grant program to assist retail power providers with the establishment and operation of energy conservation programs using targeted residential tree-planting programs, and for other purposes.</p>	<p>Introduced by Rep. Doris Matsui (D-CA)–January 15, 2020</p>	

LEGISLATION	SUMMARY	STATUS	POSITION
<a href="#">S. 3208</a> <a href="#">Regulatory</a> <a href="#">Accountability Act</a>	To improve agency rulemaking, and for other purposes.	Introduced by Sen. Rob Portman (R-OH) – January 16, 2020	
<a href="#">H.R. 5638</a> <a href="#">American</a> <a href="#">Sovereignty and</a> <a href="#">Species Protection</a> <a href="#">Act</a>	To amend the Endangered Species Act to prevent a species that is not native to the United States from being listed as an endangered species or a threatened species, to prohibit certain types of financial assistance, and for other purposes.	Introduced by Rep. Andy Biggs (R-AZ) - January 16, 2020	
<a href="#">S. 3211</a> <a href="#">Clean Water</a> <a href="#">Allotment</a> <a href="#">Modernization Act</a>	To amend the Federal Water Pollution Control Act to modify certain allotments under that Act, and for other purposes.	Introduced by Sen. Marco Rubio (R-FL) – January 16, 2020	
<a href="#">H.R. 5628</a> <a href="#">Clean Water</a> <a href="#">Allotment</a> <a href="#">Modernization Act</a>	To amend the Federal Water Pollution Control Act to modify certain allotments under that Act, and for other purposes.	Introduced by Rep. Michael Waltz (R-FL) – January 17, 2020	
<a href="#">H.R. 5636</a> <a href="#">Transparency in</a> <a href="#">Energy Production</a> <a href="#">Act of 2020</a>	To provide for the accurate reporting of fossil fuel extraction and emissions by entities with leases on public land, and for other purposes.	<p>Introduced by Rep. Alan Lowenthal (D-CA) – January 16, 2020</p> <p>Subcommittee on Energy and Mineral Resources hearing – January 28, 2020</p>	
<a href="#">H.R.5650</a> <a href="#">Federal Energy and</a> <a href="#">Water Management</a> <a href="#">Performance Act of</a> <a href="#">2020</a>	To amend the National Energy Conservation Policy Act to improve Federal energy and water performance requirements for Federal buildings and establish a Federal Energy Management Program.	Introduced by Rep. Peter Welch (D-VT) – January 16, 2020	
<a href="#">H.R.5653</a> <a href="#">Green Federal Fleet</a> <a href="#">Act</a>	To prohibit Federal agencies from purchasing or leasing new vehicles that are not zero-emission vehicles, and for other purposes.	Introduced by Rep. Julia Brownley (D-CA) – January 17, 2020	

LEGISLATION	SUMMARY	STATUS	POSITION
<a href="#">S. 3221</a> <a href="#">Farm System Reform Act of 2019</a>	<p>To place a moratorium on large concentrated animal feeding operations, to strengthen the Packers and Stockyards Act, 1921, to require country of origin labeling on beef, pork, and dairy products, and for other purposes.</p>	<p>Introduced by Sen. Cory Booker (D-NJ) – January 21, 2020</p>	
<a href="#">H. Res. 835</a> <a href="#">Expressing the sense of the House of Representatives that the Federal Government should establish a national goal of conserving at least 30 percent of the land and ocean of the United States by 2030</a>	<p>Expressing the sense of the House of Representatives that the Federal Government should establish a national goal of conserving at least 30 percent of the land and ocean of the United States by 2030.</p>	<p>Introduced by Rep. Debra Haaland (D-NM) – February 6, 2020</p>	
<a href="#">H.R. 5832</a> <a href="#">SHORE Act</a>	<p>To direct the Secretary of the Army and the Director of the Office of Management and Budget to issue regulations and submit a report to Congress on cost-benefit ratios, and for other purposes.</p>	<p>Introduced by Rep. John Katko (R-NY) – February 10, 2020</p>	
<a href="#">S. 3274</a> <a href="#">Decentralized Wastewater Grant Act of 2020</a>	<p>To amend the Federal Water Pollution Control Act to establish a decentralized wastewater grant program, and for other purposes.</p>	<p>Introduced by Sen. Cory Booker (D-NJ) – February 11, 2020</p>	



LEGISLATION	SUMMARY	STATUS	POSITION
<a href="#"><u>H.Con.Res. 89</u></a> <a href="#"><u>Encouraging the Trump Administration to maintain protections under the National Environmental Policy Act and reverse ongoing administrative actions to weaken this landmark law and its protections for American communities</u></a>	<p>Encouraging the Trump Administration to maintain protections under the National Environmental Policy Act and reverse ongoing administrative actions to weaken this landmark law and its protections for American communities.</p>	<p>Introduced by Rep. Debbie Dingell (D-MI) – February 11, 2020</p>	
<a href="#"><u>S.3288</u></a> <a href="#"><u>PUBLIC Lands Act</u></a>	<p>To provide for the protection of and investment in certain Federal land in the State of California, and for other purposes.</p>	<p>Introduced by Sen. Kamala Harris (D-CA) – February 12, 2020</p>	
<a href="#"><u>H.R. 5856</u></a> <a href="#"><u>Decentralized Wastewater Grant Act of 2020</u></a>	<p>To amend the Federal Water Pollution Control Act to establish a decentralized wastewater grant program, and for other purposes.</p>	<p>Introduced by Rep. Terri Sewell (D-AL) – February 11, 2020</p>	
<a href="#"><u>H.R. 5868</u></a> <a href="#"><u>RELIEF ACT</u></a>	<p>To amend the Act of August 18, 1941 (commonly known as the Flood Control Act of 1941), to allow a non-Federal sponsor to carry out certain work, to provide for reimbursement of costs to complete such work, and for other purposes.</p>	<p>Introduced by Rep. Jeff Fortenberry (R-NE) – February 13, 2020</p>	
<a href="#"><u>H.R. 5902</u></a> <a href="#"><u>Plastics Act of 2020</u></a>	<p>To establish a microplastics pilot program, and for other purposes.</p>	<p>Introduced by Rep. Brian Mast (R-FL) – February 14, 2020</p>	
<a href="#"><u>H.R.5986</u></a> <a href="#"><u>Environmental Justice For All Act</u></a>	<p>To restore, reaffirm, and reconcile environmental justice and civil rights, provide for the establishment of the Interagency Working Group on Environmental Justice Compliance and Enforcement, and for other purposes.</p>	<p>Introduced by Rep. Raul Grijalva (D-AZ) – February 27, 2020</p>	

LEGISLATION	SUMMARY	STATUS	POSITION
<a href="#"><u><b>H.R.6000</b></u></a> <a href="#"><u>To reauthorize a pilot program to evaluate the effectiveness of certain water-related feasibility studies carried out by non-Federal interests.</u></a>	<p>To reauthorize a pilot program to evaluate the effectiveness of certain water-related feasibility studies carried out by non-Federal interests.</p>	<p>Introduced by Rep. Mike Johnson (R-LA) – February 27, 2020</p>	
<a href="#"><u><b>H.R.6112</b></u></a> <a href="#"><u>Oil and Water Don't Mix Act of 2020</u></a>	<p>To require operators of oil and gas production facilities to take certain measures to protect drinking water, and for other purposes.</p>	<p>Introduced by Rep. Jared Huffman (D-CA) – March 5, 2020</p>	
<a href="#"><u><b>H.R.6113</b></u></a> <a href="#"><u>ARPA-H2O Act of 2020</u></a>	<p>To establish an Advanced Research Projects Agency–Water, and for other purposes.</p>	<p>Introduced by Rep. John Katko (R-NY) – March 5, 2020</p>	
<a href="#"><u><b>S.3418</b></u></a> <a href="#"><u>STORM Act</u></a>	<p>To amend the Robert T. Stafford Disaster Relief and Emergency Assistance Act to allow the Administrator of the Federal Emergency Management Agency to provide capitalization grants to States to establish revolving funds to provide hazard mitigation assistance to reduce risks from disasters and natural hazards, and other related environmental harm.</p>	<p>Introduced by Sen. Gary Peters (D-MI) – March 11, 2020</p> <p>Placed on Senate Legislative Calendar – August 10, 2020</p>	
<a href="#"><u><b>H.R.6185</b></u></a> <a href="#"><u>Save Our Springs Act of 2020</u></a>	<p>To amend the Internal Revenue Code of 1986 to impose an excise tax on the extraction of certain water for bottling, and for other purposes.</p>	<p>Introduced by Rep. Debbie Wasserman Schultz (D-FL) – March 10, 2020</p>	
<a href="#"><u><b>S. 3422</b></u></a> <a href="#"><u>Great American Outdoors Act</u></a>	<p>To amend title 54, United States Code, to establish, fund, and provide for the use of amounts in a National Parks and Public Land Legacy Restoration Fund to address the maintenance backlog of the National Park Service, the United States Fish and Wildlife Service, the Bureau of Land Management, the Forest Service, and the Bureau of Indian Education, and to provide permanent, dedicated funding for the Land and Water Conservation Fund, and for other purposes.</p>	<p>Introduced by Sen. Cory Gardner (R-CO) – March 10, 2020</p> <p>Placed on Senate Legislative Calendar – March 11, 2020</p>	

LEGISLATION	SUMMARY	STATUS	POSITION
<p><a href="#"><u>S.Res.537</u></a>  <a href="#"><u>A resolution encouraging the Trump Administration to maintain protections under the National Environmental Policy Act and reverse ongoing administrative actions to weaken this landmark law and its protections for American communities</u></a></p>	<p>Encouraging the Trump Administration to maintain protections under the National Environmental Policy Act and reverse ongoing administrative actions to weaken this landmark law and its protections for American communities.</p>	<p>Introduced by Sen. Thomas Carter (D-DE) – March 10, 2020</p>	
<p><a href="#"><u>H.R.6169</u></a>  <a href="#"><u>To require the Secretary of the Interior, the Secretary of Agriculture, and the Assistant Secretary of the Army for Civil Works to digitize and make publicly available geographic information system mapping data relating to public access to Federal land and waters for outdoor recreation, and for other purposes</u></a></p>	<p>To require the Secretary of the Interior, the Secretary of Agriculture, and the Assistant Secretary of the Army for Civil Works to digitize and make publicly available geographic information system mapping data relating to public access to Federal land and waters for outdoor recreation, and for other purposes.</p>	<p>Introduced by Rep. Russ Fulcher (D-ID) – March 10, 2020</p>	

LEGISLATION	SUMMARY	STATUS	POSITION
<a href="#">S.3480</a> <a href="#">PFAS Testing and Treatment Act of 2020</a>	To amend the Safe Drinking Water Act and the Federal Water Pollution Control Act to authorize additional assistance to address pollution from perfluoroalkyl and polyfluoroalkyl substances and other emerging contaminants, and for other purposes.	Introduced by Sen. Jeanne Shaheen (D-NH) – March 12, 2020	
<a href="#">H.R.6395</a> <a href="#">William M. (Mac) Thornberry National Defense Authorization Act for Fiscal Year 2021</a>	To authorize appropriations for fiscal year 2021 for military activities of the Department of Defense, for military construction, and for defense activities of the Department of Energy, to prescribe military personnel strengths for such fiscal year, and for other purposes.	Introduced by Rep. Adam Smith (D-WA) – March 26, 2020  Passed in the House – July 21, 2020	
<a href="#">H.R.6422</a> <a href="#">National Infrastructure Bank Act of 2020</a>	To facilitate efficient investments and financing of infrastructure projects and new job creation through the establishment of a National Infrastructure Bank, and for other purposes.	Introduced by Danny Davis (D-IL) – March 31, 2020	
<a href="#">H.R.6552</a> <a href="#">Emergency Water is a Human Right Act</a>	To prohibit water shutoffs during the COVID–19 emergency period, provide drinking and waste water assistance to households, and for other purposes.	Introduced by Rep. Rashida Tlaib (D-MI) – April 17, 2020	
<a href="#">H.R.6617</a> <a href="#">Western Water Storage Infrastructure Act</a>	To support surface and groundwater storage and supporting projects in Reclamation States, and for other purposes.	Introduced by Rep. TJ Cox (D-CA) – April 29, 2020	
<a href="#">H.R.6631</a> <a href="#">Essential Worker Protection Act of 2020</a>	To direct the Secretary of Labor to establish an interagency task force on worker protection from COVID–19, and for other purposes.	Introduced by Rep. Haley Stevens (D-MI) – April 28, 2020	
<a href="#">S.3590</a> <a href="#">Drinking Water Infrastructure Act of 2020</a>	To amend the Safe Drinking Water Act to reauthorize certain provisions, and for other purposes.	Introduced by Sen. John Barrasso (R-WY) – May 4, 2020  Placed on Senate Legislative Calendar – May 11, 2020	

LEGISLATION	SUMMARY	STATUS	POSITION
<a href="#"><u>S.3591</u></a> <a href="#"><u>America's Water Infrastructure Act of 2020</u></a>	To provide for improvements to the rivers and harbors of the United States, to provide for the conservation and development of water and related resources, to provide for water pollution control activities, and for other purposes.	Introduced by Sen. John Barrasso (R-WY) – May 4, 2020  Placed on Senate Legislative Calendar – May 11, 2020	
<a href="#"><u>S.3621</u></a> <a href="#"><u>Made in America Water Infrastructure Act of 2020</u></a>	A bill to amend the Safe Drinking Water Act to remove limitations on the required use of American iron and steel products in projects carried out using State revolving loan funds, and for other purposes.	Introduced by Sen. Tammy Baldwin (D-WI) – May 6, 2020	
<a href="#"><u>H.R.6745</u></a> <a href="#"><u>Clean Water for All Act</u></a>	To prohibit implementation of a rule defining “waters of the United States” under the Federal Water Pollution Control Act, and for other purposes.	Introduced by Rep. Peter DeFazio (D-OR) – May 11, 2020	
<a href="#"><u>H.R.6898</u></a> <a href="#"><u>IMAGINE Act</u></a>	To encourage the research and use of innovative materials and associated techniques in the construction and preservation of the domestic transportation and water infrastructure system, and for other purposes.	Introduced by Rep. David Cicilline (D-RI) – May 18, 2020	
<a href="#"><u>H.R.6922</u></a> <a href="#"><u>BASE Protection Act</u></a>	To require the Corps of Engineers to expedite review of applications for certain flood control projects near military installations, and for other purposes.	Introduced by Rep. Don Bacon (R-NE) – May 20, 2020	
<a href="#"><u>S. 3811</u></a> <a href="#"><u>Restoration of Essential Conveyance Act</u></a>	To provide financial assistance for projects to address certain subsidence impacts in the State of California, and for other purposes.	Introduced by Sen. Dianne Feinstein (D-CA) – May 21, 2020  Subcommittee on Water and Power hearing held – July 22, 2020	
<a href="#"><u>H.R.7092</u></a> <a href="#"><u>Great American Outdoors Act</u></a>	To amend title 54, United States Code, to establish, fund, and provide for the use of amounts in a National Parks and Public Land Legacy Restoration Fund to address the maintenance backlog of the National Park Service, the United States Fish and Wildlife Service, the Bureau of Land Management, the Forest Service, and the Bureau of Indian Education, and to provide permanent, dedicated funding for the Land and Water Conservation Fund, and for other purposes.	Introduced by Rep. Joe Cunningham (D-SC) – June 4, 2020	

LEGISLATION	SUMMARY	STATUS	POSITION
<a href="#"><u>H.R.7095</u></a> <a href="#"><u>INVEST in America Act</u></a>	To authorize funds for Federal-aid highways, highway safety programs, and transit programs, and for other purposes.	Introduced by Rep. Peter DeFazio (D-OR) – June 4, 2020	
<a href="#"><u>H.R.2</u></a> <a href="#"><u>Moving Forward Act</u></a>	To authorize funds for Federal-aid highways, highway safety programs, and transit programs, and for other purposes.	Introduced by Rep. Peter DeFazio (D-OR) – June 11, 2020  Passed in the House – July 1, 2020	
<a href="#"><u>H.R.7231</u></a> <a href="#"><u>Infrastructure Bank for America Act of 2020</u></a>	To establish the Infrastructure Bank for America as a corporation to serve as a lender for and investor in infrastructure projects, and for other purposes.	Introduced by Rep. Daniel Webster (R-FL) – June 15 2020	
<a href="#"><u>H.R.7243</u></a> <a href="#"><u>Identifying PFAS at Water Infrastructure Sites Act</u></a>	To require the Secretary of the Army, acting through the Chief of Engineers, to develop an inventory and carry out research with respect to PFAS, and for other purposes.	Introduced by Rep. Antonio Delgado (D-NY) – June 18, 2020	
<a href="#"><u>H.R.7280</u></a> <a href="#"><u>To amend the Internal Revenue Code of 1986 to provide an exclusion from gross income for certain wastewater management subsidies</u></a>	To amend the Internal Revenue Code of 1986 to provide an exclusion from gross income for certain wastewater management subsidies.	Introduced by Rep. Thomas Suozzi (D-NY) - June 18, 2020	
<a href="#"><u>S. 4049</u></a> <a href="#"><u>National Defense Authorization Act for Fiscal Year 2021</u></a>	To authorize appropriations for fiscal year 2021 for military activities of the Department of Defense, for military construction, and for defense activities of the Department of Energy, to prescribe military personnel strengths for such fiscal year, and for other purposes.	Introduced by Sen. James Inhofe (R-OK) - June 23, 2020	

LEGISLATION	SUMMARY	STATUS	POSITION
<a href="#">S.4188</a> <a href="#">Waters for Tomorrow Act</a>	To provide for drought preparedness and improved water supply reliability, and for other purposes.	Introduced by Sen. Kamala Harris (D-CA) – July 2, 2020  Subcommittee on Water and Power hearing held – July 22, 2020	
<a href="#">S.4189</a> <a href="#">Water for Conservation and Farming Act</a>	To provide for drought preparedness and improved water supply reliability.	Introduced by Sen. Ron Wyden (D-OR) – July 2, 2020  Subcommittee on Water and Power hearing held – July 22, 2020	
<a href="#">S.4206</a> <a href="#">A bill to amend the Water Infrastructure Finance and Innovation Act of 2014 to authorize the interest rate to be used on a secured loan to be the interest rate for United States Treasury securities of a similar maturity on the date of first disbursement of the loan, and for other purposes.</a>	To amend the Water Infrastructure Finance and Innovation Act of 2014 to authorize the interest rate to be used on a secured loan to be the interest rate for United States Treasury securities of a similar maturity on the date of first disbursement of the loan, and for other purposes.	Introduced by Sen. Jeff Merkley (D-OR) – July 2, 2020	

LEGISLATION	SUMMARY	STATUS	POSITION
<a href="#"><u>S.4308</u></a> <a href="#"><u>Special Districts</u></a> <a href="#"><u>Provide Essential</u></a> <a href="#"><u>Services Act</u></a>	To amend the Social Security Act to include special districts in the coronavirus relief fund, to direct the Secretary to include special districts as an eligible issuer under the Municipal Liquidity Facility, and for other purposes.	Introduced by Sen. Kyrsten Sinema (D-AZ) – July 23, 2020	
<a href="#"><u>H.R.7575</u></a> <a href="#"><u>Water Resources</u></a> <a href="#"><u>Development Act of</u></a> <a href="#"><u>2020</u></a>	To provide for improvements to the rivers and harbors of the United States, to provide for the conservation and development of water and related resources, and for other purposes.	Introduced by Rep. Peter DeFazio (D-OR) – July 13, 2020  Passed in the House, Received in the Senate - July 30, 2020	
<a href="#"><u>H.R.7608</u></a> <a href="#"><u>State, Foreign</u></a> <a href="#"><u>Operations,</u></a> <a href="#"><u>Agriculture, Rural</u></a> <a href="#"><u>Development,</u></a> <a href="#"><u>Interior,</u></a> <a href="#"><u>Environment,</u></a> <a href="#"><u>Military</u></a> <a href="#"><u>Construction, and</u></a> <a href="#"><u>Veterans Affairs</u></a> <a href="#"><u>Appropriations Act,</u></a> <a href="#"><u>2021</u></a>	Making appropriations for the Department of State, foreign operations, and related programs for the fiscal year ending September 30, 2021, and for other purposes.	Introduced by Rep. Nita Lowery (D-NY) – July 13, 2020  Passed in the House, Received in the Senate – July 30, 2020	
<a href="#"><u>H.R.7610</u></a> <a href="#"><u>Agriculture, Rural</u></a> <a href="#"><u>Development, Food</u></a> <a href="#"><u>and Drug</u></a> <a href="#"><u>Administration, and</u></a> <a href="#"><u>Related Agencies</u></a> <a href="#"><u>Appropriations Act,</u></a> <a href="#"><u>2021</u></a>	Making appropriations for Agriculture, Rural Development, Food and Drug Administration, and Related Agencies programs for the fiscal year ending September 30, 2021, and for other purposes.	Introduced by Rep. Sanford Bishop (D-GA) – July 13, 2020	



LEGISLATION	SUMMARY	STATUS	POSITION
<a href="#"><u>H.R.7612</u></a> <a href="#"><u>Department of the Interior, Environment, and Related Agencies Appropriations Act, 2021</u></a>	Making appropriations for the Department of the Interior, environment, and related agencies for the fiscal year ending September 30, 2021, and for other purposes.	Introduced by Rep. Betty McCollum (D-MN) – July 14, 2020	
<a href="#"><u>H.R.7613</u></a> <a href="#"><u>Energy and Water Development and Related Agencies Appropriations Act, 2021</u></a>	Making appropriations for energy and water development and related agencies for the fiscal year ending September 30, 2021, and for other purposes.	Introduced by Rep. Marcy Kaptur (D-OH) – July 15, 2020  Placed on the Union Calendar – July 15, 2020	
<a href="#"><u>S. 4336</u></a> <a href="#"><u>RESILIENT Act</u></a>	To provide for the improvement of rural infrastructure in the United States, and for other purposes.	Introduced by Sen. Michael Bennet (D-CO) – July 28, 2020	
<a href="#"><u>S.4352</u></a> <a href="#"><u>Border Water Quality Restoration and Protection Act of 2020</u></a>	To provide for the water quality restoration of the Tijuana River and the New River, and for other purposes.	Introduced by Sen. Dianne Feinstein (D-CA) – July 29, 2020	
<a href="#"><u>S.4362</u></a> <a href="#"><u>Emergency Water and Energy is a Human Right Act</u></a>	To prohibit water and power shutoffs during the COVID–19 emergency period, provide drinking and wastewater assistance to households, and for other purposes.	Introduced by Sen. Jeff Merkley (D-OR) – July 29, 2020	
<a href="#"><u>S.4401</u></a> <a href="#"><u>Environmental Justice For All Act</u></a>	To restore, reaffirm, and reconcile environmental justice and civil rights, provide for the establishment of the Interagency Working Group on Environmental Justice Compliance and Enforcement, and for other purposes.	Introduced by Sen. Kamala Harris (D-CA) – August 3, 2020	

LEGISLATION	SUMMARY	STATUS	POSITION
<a href="#"><u>S.4402</u></a> <a href="#"><u>A bill to amend the Federal Water Pollution Control Act to clarify certain activities that would have been authorized under Nationwide Permit 12 and other Nationwide Permits, and for other purposes</u></a>	<p>To amend the Federal Water Pollution Control Act to clarify certain activities that would have been authorized under Nationwide Permit 12 and other Nationwide Permits, and for other purposes.</p>	<p>Introduced by Sen. John Cornyn (R-TX) – August 3, 2020</p>	
<a href="#"><u>S.4431</u></a> <a href="#"><u>Emergency Wildfire and Public Safety Act of 2020</u></a>	<p>To increase wildfire preparedness and response throughout the United States, and for other purposes.</p>	<p>Introduced by Sen. Dianne Feinstein (D-CA) – August 4, 2020</p> <p>Energy and Natural Resources Subcommittee on Public Lands, Forests, and Mining hearing held – September 16, 2020</p>	
<a href="#"><u>H.R.7991</u></a> <a href="#"><u>Border Water Quality Restoration and Protection Act of 2020</u></a>	<p>To provide for the water quality restoration of the Tijuana River and the New River, and for other purposes.</p>	<p>Introduced by Rep. Juan Vargas (D-CA) – August 7, 2020</p>	
<a href="#"><u>H.R.8166</u></a> <a href="#"><u>Western Water Storage Infrastructure Act</u></a>	<p>To support surface and groundwater storage and supporting projects in Reclamation States, and for other purposes.</p>	<p>Introduced by Rep. TJ Cox (D-CA) – September 4, 2020</p>	

LEGISLATION	SUMMARY	STATUS	POSITION
<a href="#">H.R.8217</a> <a href="#">WIFIA Improvement Act of 2020</a>	To amend the Water Infrastructure Finance and Innovation Act of 2014 with respect to the final maturity date of certain loans, and for other purposes.	Introduced by Rep. John Garamendi (D-CA) – September 11, 2020	
<a href="#">H.R.8292</a> <a href="#">FUELS Act</a>	To amend the Water Resources Reform and Development Act of 2014 with respect to the application of the Spill Prevention, Control, and Countermeasure rule to certain farms, and for other purposes	Introduced by Rep. Eric Crawford (R-AR) – September 17, 2020	
<a href="#">H.R.8337</a> <a href="#">Continuing Appropriations Act, 2021 and Other Extensions Act</a>	Making continuing appropriations for fiscal year 2021, and for other purposes.	Introduced by Rep. Nita Lowey (D-NY) – September 22, 2020  Became Public Law No: 166-159 – October 1, 2020	
<a href="#">S.4664</a> <a href="#">A bill to amend the Internal Revenue Code of 1986 to provide an exclusion from gross income for certain waste water management subsidies</a>	To amend the Internal Revenue Code of 1986 to provide an exclusion from gross income for certain waste water management subsidies.	Introduced by Sen. Kirsten Gillibrand (D-NY) – September 23, 2020	
<a href="#">S.4681</a> <a href="#">Plastic Pellet Free Waters Act</a>	To require the Administrator of the Environmental Protection Agency to promulgate certain limitations with respect to pre-production plastic pellet pollution, and for other purposes.	Introduced by Sen. Tom Udall (D-NM) – September 24, 2020	

LEGISLATION	SUMMARY	STATUS	POSITION
<p><a href="#"><b>S.Res.714</b></a>  <a href="#">A resolution encouraging the Administrator of the Environmental Protection Agency to maintain and strengthen requirements under the Clean Water Act and reverse ongoing administrative actions to weaken the Clean Water Act and protections for waters of the United States</a></p>	<p>Encouraging the Administrator of the Environmental Protection Agency to maintain and strengthen requirements under the Clean Water Act and reverse ongoing administrative actions to weaken the Clean Water Act and protections for waters of the United States.</p>	<p>Introduced by Sen. Tammy Duckworth (D-IL) – September 23, 2020</p>	
<p><a href="#"><b>H.R.8605</b></a>  <a href="#">Community Readiness Act</a></p>	<p>To authorize the Secretary of Health and Human Services, in consultation with the Administrator of the Environmental Protection Agency to award grants to certain entities to conduct research on, or to establish, wastewater surveillance and other early warning systems, and for other purposes.</p>	<p>Introduced by Rep. Andy Kim (D-NJ) – October 16, 2020</p>	

## COVID-19 RELIEF LEGISLATION

LEGISLATION	SUMMARY	STATUS	POSITION
<a href="#"><u>H.R.6074</u></a> <a href="#"><u>Coronavirus</u></a> <a href="#"><u>Preparedness and</u></a> <a href="#"><u>Response</u></a> <a href="#"><u>Supplemental</u></a> <a href="#"><u>Appropriations Act,</u></a> <a href="#"><u>2020</u></a>	Making emergency supplemental appropriations for the fiscal year ending September 30, 2020, and for other purposes.	Introduced by Rep. Nita Lowey (D-NY) – March 4, 2020  Became Public Law No: 116-123 – March 6, 2020	
<a href="#"><u>S.3415</u></a> <a href="#"><u>Paid Sick Days for</u></a> <a href="#"><u>Public Health</u></a> <a href="#"><u>Emergencies and</u></a> <a href="#"><u>Personal and Family</u></a> <a href="#"><u>Care Act</u></a>	To allow Americans to earn paid sick time so that they can address their own health needs and the health needs of their families.	Introduced by Sen. Patty Murray (D-WA) – March 5, 2020	
<a href="#"><u>H.R.6201</u></a> <a href="#"><u>Families First</u></a> <a href="#"><u>Coronavirus</u></a> <a href="#"><u>Response Act</u></a>	Making emergency supplemental appropriations for the fiscal year ending September 30, 2020, and for other purposes.	Introduced by Rep. Nita Lowey (D-NY) – March 11, 2020  Became Public Law No: 116-127 – March 18, 2020	
<a href="#"><u>H.R.6198</u></a> <a href="#"><u>Emergency Paid</u></a> <a href="#"><u>Leave Act of 2020</u></a>	To provide emergency paid leave benefits to certain individuals affected by COVID-19, and for other purposes.	Introduced by Rep. Stephanie Murphy (D-FL) – Introduced March 11, 2020	
<a href="#"><u>H.R.6150</u></a> <a href="#"><u>Paid Sick Days for</u></a> <a href="#"><u>Public Health</u></a> <a href="#"><u>Emergencies and</u></a> <a href="#"><u>Personal and Family</u></a> <a href="#"><u>Care Act</u></a>	To allow Americans to earn paid sick time so that they can address their own health needs and the health needs of their families.	Introduced by Rep. Rosa DeLauro (D-CT) – March 9, 2020	

LEGISLATION	SUMMARY	STATUS	POSITION
<a href="#"><u>H.R.6220</u></a> <a href="#"><u>Emergency Family and Medical Leave Expansion Act</u></a>	To amend the Family and Medical Leave Act of 1993 to provide for leave with respect to a public health emergency, and for other purposes.	Introduced by Rep. Robert Scott (D-VA) - March 12, 2020	
<a href="#"><u>S.3476</u></a> <a href="#"><u>Coronavirus Worker Relief Act</u></a>	To provide for unemployment benefits to workers affected by the 2019 Novel Coronavirus.	Introduced by Sen. Gary Peters (D-MI) - March 12, 2020	
<a href="#"><u>S.3548</u></a> <a href="#"><u>CARES Act</u></a>	To provide emergency assistance and health care response for individuals, families, and businesses affected by the 2020 coronavirus pandemic.	Introduced by Sen. Mitch McConnell (R-KY) – March 19, 2020  Committee on Small Business and Entrepreneurship hearing held – June 3, 2020	
<a href="#"><u>H.R.6321</u></a> <a href="#"><u>Financial Protections and Assistance for America's Consumers, States, Businesses, and Vulnerable Populations Act</u></a>	To provide financial protections and assistance for America’s consumers, States, businesses, and vulnerable populations during the COVID-19 emergency and to recover from the emergency.	Introduced by Rep. Maxine Waters (D-CA) – March 23, 2020	
<a href="#"><u>H.R.6328</u></a> <a href="#"><u>Emergency Relief for State, Territorial and Local Governments Act of 2020</u></a>	To authorize Federal reserve banks to purchase COVID–19 related municipal issuances, and for other purposes.	Introduced by Rep. Rashida Tlaib (D-MI) – March 23, 2020	

LEGISLATION	SUMMARY	STATUS	POSITION
<a href="#"><u>H.R.6379</u></a> <a href="#"><u>Take Responsibility for Workers and Families Act</u></a>	Making emergency supplemental appropriations for the fiscal year ending September 30, 2020, and for other purposes.	Introduced by Rep. Nita Lowery (D-NY) – March 23, 2020	
<a href="#"><u>H.R. 6361</u></a> <a href="#"><u>Relief for Small Businesses and Nonprofits Act</u></a>	To provide loan and obligation payment relief for small businesses and nonprofits affected by the COVID–19 emergency, and for other purposes.	Introduced by Rep. Ed Perlmutter (D-CO) – March 23, 2020	
<a href="#"><u>S.3584</u></a> <a href="#"><u>COVID-19 Workers First Protection Act of 2020</u></a>	To direct the Secretary of Labor to issue an emergency temporary standard that requires certain employers to develop and implement a comprehensive infectious disease exposure control plan to protect employees in the health care sectors and other employees at elevated risk from exposure to SARS–CoV–2, and for other purposes.	Introduced by Sen. Tammy Baldwin (D-WI) – March 25, 2020	
<a href="#"><u>H.R. 6402</u></a> <a href="#"><u>COVID-19 Workforce Emergency Response Act</u></a>	To provide State and local workforce systems flexibility and financial support to respond to the COVID–19 national emergency.	Introduced by Rep. Andy Levin (D-MI) – March 26, 2020	
<a href="#"><u>H.R.748</u></a> <a href="#"><u>CARES Act</u></a>	To amend the Internal Revenue Code of 1986 to repeal the excise tax on high cost employer-sponsored health coverage.	Introduced by Rep. Joe Courtney (D-CT) – March 27, 2020  Became Public Law No: 116-136 – March 27, 2020	

LEGISLATION	SUMMARY	STATUS	POSITION
<a href="#"><u><b>H.R.6410</b></u></a> <a href="#"><u>To direct the President to use authority under the Defense Production Act of 1950 to ensure an adequate supply of equipment necessary for limiting the spread of COVID-19.</u></a>	To direct the President to use authority under the Defense Production Act of 1950 to ensure an adequate supply of equipment necessary for limiting the spread of COVID-19.	Introduced by Rep. John Larson (D-CT) – March 27, 2020	
<a href="#"><u><b>H.R.6423</b></u></a> <a href="#"><u>To provide for a temporary debt collection moratorium during the COVID-19 emergency period, and for other purposes.</u></a>	To provide for a temporary debt collection moratorium during the COVID-19 emergency period, and for other purposes.	Introduced by Rep. Al Lawson (D-FL) – March 31, 2020	
<a href="#"><u><b>H.R.6431</b></u></a> <a href="#"><u>Made in America Emergency Preparedness Act</u></a>	To require the creation of a national commission to prepare for future national emergencies, and for other purposes.	Introduced by Rep. Brian Fitzpatrick (R-PA) – April 3, 2020	
<a href="#"><u><b>H.R.6472</b></u></a> <a href="#"><u>COVID-19 Price Gouging Prevention Act</u></a>	To prohibit price gouging in connection with the public health emergency resulting from COVID–19, and for other purposes.	Introduced by Rep. Janice Schakowsky (D-IL) – April 7, 2020	



LEGISLATION	SUMMARY	STATUS	POSITION
<a href="#"><u>H.R.6460</u></a> <a href="#"><u>To provide funding for needed child and adult care so that essential workers can report to work during the COVID-19 pandemic.</u></a>	<p>To provide funding for needed child and adult care so that essential workers can report to work during the COVID-19 pandemic.</p>	<p>Introduced by Rep. Danny Davis (D-IL) – April 7, 2020</p>	
<a href="#"><u>H.R.6525</u></a> <a href="#"><u>Reopen America Act of 2020</u></a>	<p>To provide the necessary Federal financial and logistical support so States can reopen their economies once periods of isolation have sufficiently reduced coronavirus infection and transmission rates, and with adequate testing and other safeguards to ensure infection rates do not exceed medical resources, and virus transmission rates are maintained below 1 and thereby steadily reduce the number of infected, and for other purposes.</p>	<p>Introduced by Rep. Jamie Raskin (D-MD) – April 17, 2020</p>	
<a href="#"><u>H.R. 6552</u></a> <a href="#"><u>Emergency Water is Human Right Act</u></a>	<p>To prohibit water shutoffs during the COVID–19 emergency period, provide drinking and waste water assistance to households, and for other purposes.</p>	<p>Introduced by Rep. Rashida Tlaib (D-MI) – April 17, 2020</p>	
<a href="#"><u>H.R.6559</u></a> <a href="#"><u>COVID-19 Every Worker Protection Act of 2020</u></a>	<p>To require the Occupational Safety and Health Administration to promulgate an emergency temporary standard to protect employees from occupational exposure to SARS–CoV–2, and for other purposes.</p>	<p>Introduced by Rep. Robert Scott (D-VA) – April 21, 2020</p>	
<a href="#"><u>H.R. 266</u></a> <a href="#"><u>Paycheck Protection Program and Health Care Enhancement Act</u></a>	<p>Making appropriations for the Department of the Interior, environment, and related agencies for the fiscal year ending September 30, 2019, and for other purposes.</p>	<p>Introduced by Rep. Betty McCollum (D-MN) – April 24, 2020</p> <p>Became Public Law No: 116-139 – April 24, 2020</p>	
<a href="#"><u>H.R. 6631</u></a> <a href="#"><u>Essential Worker Protection Act of 2020</u></a>	<p>To direct the Secretary of Labor to establish an interagency task force on worker protection from COVID–19, and for other purposes.</p>	<p>Introduced by Rep. Haley Stevens (D-MI) – April 28, 2020</p>	

LEGISLATION	SUMMARY	STATUS	POSITION
<a href="#">H.R.6652</a> <a href="#">Flexibility for Localities and Eligibility Expansion Act of 2020</a>	To amend title VI of the Social Security Act to expand the permissible use of funds under the Coronavirus Relief Fund.	Introduced by Rep. Don Bacon (R-NE) – May 1, 2020	
<a href="#">H.R. 6653</a> <a href="#">MASKS ON Act</a>	To require the Director of the Centers for Disease Control and Prevention to carry out a national public outreach campaign regarding the proper use of personal protective equipment to minimize personal risk of exposure to, and risk of spreading, the virus that causes COVID-19, and for other purposes.	Introduced by Rep. Daniel Lipinski (D-IL) – May 1, 2020	
<a href="#">H.R.6699</a> <a href="#">Opportunities for Heroes Act of 2020</a>	To establish a commission to determine essential employment during the COVID-19 crisis period and provide loan repayment and education credit to workers employed in such essential employment during such crisis, and for other purposes.	Introduced by Rep. Ann Kuster (D-NH) – May 5, 2020	
<a href="#">H.R.6705</a> <a href="#">Coronavirus State and Local Financial Assistance Act</a>	To require the Secretary of the Treasury to establish a State and Local Government Coronavirus Relief Program to make grants to States to make up for lost revenue due to COVID-19 and social distancing steps taken by the State and political subdivisions of the State, and for other purposes.	Introduced by Rep. Cynthia Axne (D-IA) – May 5, 2020	
<a href="#">S.3627</a> <a href="#">Medical Supply Transparency and Delivery Act</a>	A bill to provide for the expedited and transparent procurement and distribution of equipment and supplies needed to combat COVID-19.	Introduced by Sen. Tammy Badlwin (D-WI) – May 6, 2020	
<a href="#">S.3671</a> <a href="#">State &amp; Local Emergency Stabilization Fund Act of 2020</a>	To amend title VI of the Social Security Act to provide additional funding for States, Tribal governments, and local communities due to the Coronavirus Disease 2019 (COVID-19) public health emergency, and for other purposes.	Introduced by Rep. Jack Reed (D-RI) – May 7, 2020	
<a href="#">H.R. 6748</a> <a href="#">Direct Support for Communities Act</a>	To provide funding for cities, counties, and other units of general local government to prevent, prepare for, and respond to coronavirus.	Introduced by Rep. Antonio Delgado (D-NY) – May 8, 2020	

LEGISLATION	SUMMARY	STATUS	POSITION
<a href="#"><u>H.R.6760</u></a> <a href="#"><u>Fair Housing Further Enforcement Emergency Act of 2020</u></a>	To authorize assistance for fair housing enforcement activities to respond to the COVID-19 pandemic, and for other purposes.	Introduced by Rep. Al Green (D-TX) – May 8, 2020	
<a href="#"><u>S.3672</u></a> <a href="#"><u>Pandemic TANF Assistance Act</u></a>	To provide States and Indian Tribes with flexibility in administering the temporary assistance for needy families program due to the public health emergency with respect to the Coronavirus Disease (COVID–19), to make emergency grants to States and Indian Tribes to provide financial support for low-income individuals affected by that public health emergency, and for other purposes.	Introduced by Sen. Ron Wyden (D-OR) – May 11, 2020	
<a href="#"><u>S.3682</u></a> <a href="#"><u>A bill to provide States, Tribal governments, and local governments with spending discretion for part of their Coronavirus Relief Fund payment</u></a>	To provide States, Tribal governments, and local governments with spending discretion for part of their Coronavirus Relief Fund payment.	Introduced by Sen. Mike Rounds (R-SD) – May 11, 2020	
<a href="#"><u>S.3685</u></a> <a href="#"><u>Emergency Rental Assistance and Rental Market Stabilization Act of 2020</u></a>	To provide emergency rental assistance under the Emergency Solutions Grants program of the Secretary of Housing and Urban Development in response to the public health emergency resulting from the coronavirus, and for other purposes.	Introduced by Sen. Sherrod Brown (D-OH) – May 12, 2020	
<a href="#"><u>H.R.6800</u></a> <a href="#"><u>The Heroes Act</u></a>	Making emergency supplemental appropriations for the fiscal year ending September 30, 2020, and for other purposes.	Introduced by Rep. Nita Lowey (D-NY) – May 12, 2020  Placed on Senate Legislative Calendar – May 21, 2020	

LEGISLATION	SUMMARY	STATUS	POSITION
<a href="#"><u>H.R.6820</u></a> <a href="#"><u>Emergency Rental Assistance and Rental Market Stabilization Act of 2020</u></a>	To provide emergency rental assistance under the Emergency Solutions Grants program of the Secretary of Housing and Urban Development in response to the public health emergency resulting from the coronavirus, and for other purposes.	Introduced by Rep. Denny Heck (D-WA) – May 12, 2020	
<a href="#"><u>S.3728</u></a> <a href="#"><u>Critical Infrastructure Employee Protection Act of 2020</u></a>	To require the Secretary of Transportation to support the efforts of State and local governments to provide for priority testing of essential critical infrastructure workers with respect to the Coronavirus Disease 2019 (COVID–19), and for other purposes.	Introduced by Sen. Roger Wicker (R-MS) – May 13, 2020	
<a href="#"><u>S.3767</u></a> <a href="#"><u>SMART Act</u></a>	To amend title VI of the Social Security Act to establish a Coronavirus Local Community Stabilization Fund.	Introduced by Sen. Steve Daines (R-MT) – May 19, 2020	
<a href="#"><u>H.R.6918</u></a> <a href="#"><u>Paycheck Recovery Act of 2020</u></a>	To direct the Secretary of the Treasury to establish a grant program for employers adversely affected by COVID–19, and for other purposes.	Introduced by Rep. Pramilla Jayapal (D-WA) – May 19, 2020	
<a href="#"><u>H.R.6954</u></a> <a href="#"><u>SMART Act</u></a>	To amend title VI of the Social Security Act to establish a Coronavirus Local Community Stabilization Fund	Introduced by Rep. Mikie Sherrill (D-NJ) – May 19, 2020	
<a href="#"><u>S.3830</u></a> <a href="#"><u>United States Pandemic Relief Bonds Act of 2020</u></a>	To amend title 31, United States Code, to authorize the issuance of United States Pandemic Bonds to aid in the funding of relief efforts related to coronavirus disease 2019 (COVID–19).	Introduced by Sen. Dan Sullivan (D-AK) – May 21, 2019	

LEGISLATION	SUMMARY	STATUS	POSITION
<a href="#">S.3833</a> <a href="#">Paycheck Protection Program Extension Act</a>	To extend the loan forgiveness period for the paycheck protection program, and for other purposes.	Introduced by Sen. Marco Rubio (R-FL) – May 21, 2020  Placed on Senate Legislative Calendar – June 1, 2020	
<a href="#">H.R. 6973</a> <a href="#">PPE Act</a>	To amend the paycheck protection program of the Small Business Administration to include costs related to the provision of personal protective equipment as an allowable use of a covered loan, and for other purposes.	Introduced by Rep. Abby Filkenauer (D-IA) – May 22, 2020	
<a href="#">H.R.6981</a> <a href="#">PPP DEAL Act</a>	To extend the covered period for loan forgiveness and the rehiring period under the CARES Act, and for other purposes.	Introduced by Rep. Connor Lamb (D-PA) - May 22, 2020	
<a href="#">H.R.7010</a> <a href="#">Paycheck Protection Program Flexibility Act of 2020</a>	To amend the Small Business Act and the CARES Act to modify certain provisions related to the forgiveness of loans under the paycheck protection program, to allow recipients of loan forgiveness under the paycheck protection program to defer payroll taxes, and for other purposes.	Introduced by Rep. Dean Phillips (D-MN) – May 26, 2020  Became Public Law No: 116-142 – June 5, 2020	
<a href="#">H.R.7065</a> <a href="#">To require States to certify a process for distributing Coronavirus Relief Funds to local governments</a>	To require States to certify a process for distributing Coronavirus Relief Funds to local governments.	Introduced by Rep. Kevin Brady (R-TX) – June 1, 2020	

LEGISLATION	SUMMARY	STATUS	POSITION
<a href="#"><u>H.R.7073</u></a> <a href="#"><u>Special Districts</u></a> <a href="#"><u>Provide Essential</u></a> <a href="#"><u>Services Act</u></a>	<p>To amend the Social Security Act to include special districts in the coronavirus relief fund, to direct the Secretary to include special districts as an eligible issuer under the Municipal Liquidity Facility, and for other purposes.</p>	<p>Introduced by Rep. John Garamendi (D-CA) – June 1, 2020</p>	<p><i>Support</i></p>
<a href="#"><u>H.R.7090</u></a> <a href="#"><u>Coronavirus County</u></a> <a href="#"><u>Relief and Stability</u></a> <a href="#"><u>Act</u></a>	<p>To amend title VI of the Social Security Act to establish the Coronavirus County Relief Fund, and for other purposes.</p>	<p>Introduced Rep. Paul Cook (R-CA) – June 4 2020</p>	
<a href="#"><u>H.R.7094</u></a> <a href="#"><u>Flexibility for States</u></a> <a href="#"><u>and Localities Act</u></a>	<p>To amend title VI of the Social Security Act to expand the permissible use of funds under the Coronavirus Relief Fund.</p>	<p>Introduced by Rep. Warren Davidson (R-OH) – June 4, 2020</p>	
<a href="#"><u>S.4125</u></a> <a href="#"><u>Paycheck Protection</u></a> <a href="#"><u>Program Extension</u></a> <a href="#"><u>and Modification</u></a> <a href="#"><u>Act of 2020</u></a>	<p>To extend the paycheck protection program and to provide supplemental loans to recipients of loans under the paycheck protection program, and for other purposes.</p>	<p>Introduced by Sen. Cory Gardner (R-CO) – July 1, 2020</p>	
<a href="#"><u>H.R.7985</u></a> <a href="#"><u>Emergency</u></a> <a href="#"><u>Assistance for Rural</u></a> <a href="#"><u>Water Systems Act</u></a>	<p>To provide for assistance to rural water and waste disposal systems affected by the COVID–19 pandemic, and for other purposes.</p>	<p>Introduced by Rep. David Rouzer (R-NC) – August 7, 2020</p>	

LEGISLATION	SUMMARY	STATUS	POSITION
<a href="#">H.R.8266</a> <a href="#">FEMA Assistance Relief Act of 2020</a>	To modify the Federal cost share of certain emergency assistance provided under the Robert T. Stafford Disaster Relief and Emergency Assistance Act, to modify the activities eligible for assistance under the emergency declaration issued by the President on March 13, 2020 relating to COVID-19, and for other purposes.	Introduced by Rep. Peter DeFazio (D-OR) – September 16, 2020  Ordered to be Reported (Amended) by Voice Vote – September 30, 2020	
<a href="#">S.4633</a> <a href="#">Emergency Assistance for Rural Water Systems Act of 2020</a>	To provide for assistance to rural water, wastewater, and waste disposal systems affected by the COVID–19 pandemic, and for other purposes.	Introduced by Sen. Jeanne Shaheen (D-NH) – September 21, 2020	
<a href="#">H.R. 8406</a> <a href="#">The Heroes Act</a>	Making emergency supplemental appropriations for the fiscal year ending September 30, 2021, and for other purposes.	Introduced by Rep. Nita Lowey (D-NY) – September 29, 2020	
<a href="#">S.4775</a> <a href="#">Delivering Immediate Relief to America's Families, Schools and Small Businesses Act</a>	To provide continued emergency assistance, educational support, and health care response for individuals, families, and businesses affected by the 2020 coronavirus pandemic	Introduced by Sen. Mitch McConnell (R-KY) – October 1, 2020	

LEGISLATION	SUMMARY	STATUS	POSITION
<a href="#">S.4773</a> <a href="#">Continuing the Paycheck Protection Program Act</a>	To establish the Paycheck Protection Program Second Draw Loan, and for other purposes.	Introduced by Sen. Susan Collins (R-ME) – October 1, 2020	
<b>H.R.8474</b> To provide for a Community-Based Emergency and Non-Emergency Response Grant Program	<i>Text is not yet available.</i>	Introduced by Rep. Karen Bass (D-CA) – October 1, 2020	
<a href="#">H.R.8504</a> <a href="#">Payroll Support Program Extension Act</a>	To extend the Payroll Support Program, and for other purposes.	Introduced by Rep. Peter DeFazio (D-OR) – October 2, 2020	



December 7, 2020 JPA Board Meeting

TO: JPA Board of Directors

FROM: Finance & Administration

---

**Subject : Financial Review: First Quarter of Fiscal Year 2020-21**

---

**SUMMARY:**

The first quarter financial review presents data as of September 30, 2020. It is important to note that due to the timing of various projects and payments, the first quarter report should primarily be used to identify areas where an emerging trend may affect the JPA's position at fiscal year-end.

**RECOMMENDATION(S):**

Receive and file the financial review for the first quarter of Fiscal Year 2020-21.

**FISCAL IMPACT:**

No

**ITEM BUDGETED:**

No

**FINANCIAL IMPACT:**

There is no financial impact associated with this action.

**GOALS:**

Ensure Effective Utilization of the Public's Assets and Money

The JPA's first quarter net uses of funds in Fiscal Year 2020-21 totaled \$4.4 million, compared to \$6.4 million for the same period in Fiscal Year 2019-20. There were year-over-year increases in operating revenues (3.0%) and operating expenditures (22.9%). The increase in revenues was primarily due to higher recycled water sales. The increase in operating expenditures was primarily due to the startup of the Pure Water Demonstration Project.

Capital project expenditures were approximately \$2.7 million less than the prior year. When comparing to Fiscal Year 2020-21 budget estimates through the first quarter, actual

operating revenues were approximately \$59,200 (6.2%) below budget estimates. Actual expenditures were approximately \$388,000 (8.7%) above budget estimates. Capital project expenditures were approximately \$4.3 million budget estimates.

Prepared by: Angela Saccareccia, Finance Manager

**ATTACHMENTS:**

Attachment A

Attachment B

## Joint Powers Authority Operations

### Quarterly Update - Comparison to Budget & Prior Year at September 30, 2020

	FY 19-20 Actual YTD	FY 20-21 Budget YTD	FY 20-21 Actual YTD
Total Operating Revenues	\$ 871,394	\$ 956,435	\$ 897,238
RW Pump Station	353,739	279,030	470,059
RW Tanks & Reservoirs	23,202	18,759	33,393
RW System Operations	-	4,501	16,884
RW Distribution	8,950	27,211	52,555
PWP Demonstration Plant	-	247,356	211,051
Sewer	20,307	53,262	21,757
Waste Water Treatment	2,033,135	2,070,725	2,380,724
Composting	1,320,592	1,408,016	1,382,446
Centrate Treatment	47,843	76,861	51,934
Adminstration	271,717	266,245	219,200
Total Operating Expenses	4,079,485	4,451,965	4,840,003
Net Operating (Expenses)	\$ (3,208,091)	\$ (3,495,529)	\$ (3,942,765)

**Joint Powers Authority Operations**  
**Quarterly Update - Comparison to Budget & Prior Year at September 30, 2020**

	<u>FY 18-19 Actual YTD</u>	<u>FY 19-20 Budget YTD</u>	<u>FY 19-20 Actual YTD</u>
<b><u>Las Virgenes Share:</u></b>			
<b><u>Total Revenues</u></b>			
Operating Revenues	\$ 615,204	\$ 675,243	\$ 633,450
Total Revenues	<u>615,204</u>	<u>675,243</u>	<u>633,450</u>
<b><u>Total Expenses</u></b>			
Operating Expenses	\$ 2,732,489	\$ 2,981,981	\$ 3,334,762
Capital Project Expenses	<u>2,283,739</u>	<u>3,377,066</u>	<u>344,455</u>
Total Expenses	<u>5,016,228</u>	<u>6,359,047</u>	<u>3,679,217</u>
<b>Net (Uses) of Funds - LV</b>	<u>\$ (4,401,024)</u>	<u>\$ (5,683,804)</u>	<u>\$ (3,045,767)</u>
<b><u>Triunfo Share:</u></b>			
<b><u>Total Revenues</u></b>			
Operating Revenues	\$ 256,190	\$ 281,192	\$ 263,788
Total Revenues	<u>256,190</u>	<u>281,192</u>	<u>263,788</u>
<b><u>Total Expenses</u></b>			
Operating Expenses	\$ 1,346,996	\$ 1,469,984	\$ 1,505,241
Capital Project Expenses	<u>951,019</u>	<u>1,406,314</u>	<u>143,441</u>
Total Expenses	<u>2,298,015</u>	<u>2,876,298</u>	<u>1,648,682</u>
<b>Net (Uses) of Funds - TWSD</b>	<u>\$ (2,041,825)</u>	<u>\$ (2,595,105)</u>	<u>\$ (1,384,894)</u>
<b>Total JPA Net (Uses) of Funds</b>	<u>\$ (6,442,849)</u>	<u>\$ (8,278,909)</u>	<u>\$ (4,430,661)</u>

**Joint Powers Authority Operations**  
**Quarterly Update - Comparison to Budget & Prior Year at September 30, 2020**

	<u>FY 18-19 Actual YTD</u>	<u>FY 19-20 Budget YTD</u>	<u>FY 19-20 Actual YTD</u>
<b><u>Total Revenues</u></b>			
Operating Revenues	\$ 871,394	\$ 956,435	\$ 897,238
Total Revenues	<u>871,394</u>	<u>956,435</u>	<u>897,238</u>
<b><u>Total Expenses</u></b>			
Operating Expenses	\$ 4,079,485	\$ 4,451,965	\$ 4,840,003
Capital Project Expenses	<u>3,234,758</u>	<u>4,783,380</u>	<u>487,896</u>
Other	<u>-</u>	<u>-</u>	<u>-</u>
Total Expenses	<u>7,314,243</u>	<u>9,235,345</u>	<u>5,327,899</u>
<b>Net (Uses) of Funds</b>	<u>\$ (6,442,849)</u>	<u>\$ (8,278,909)</u>	<u>\$ (4,430,661)</u>
<b>Las Virgenes Share</b>	<u>(4,548,651)</u>	<u>(5,683,804)</u>	<u>(3,045,767)</u>
<b>Triunfo Share</b>	<u>(1,894,198)</u>	<u>(2,595,105)</u>	<u>(1,384,894)</u>

**Las Virgenes - Triunfo Joint Powers Authority**  
**Capital Improvement Project Status**  
**September 30, 2020**

<b>Job # - Description</b>	<b>LV %</b>	<b>TWSD %</b>	<b>Total Project Appropriations</b>	<b>Prior Year Expenditures</b>	<b>Current Year Expenditures</b>	<b>Total Project Expenditures</b>	<b>Project Balance</b>	<b>LV Balance</b>	<b>TWSD Balance</b>
<b>Multi-Year Projects</b>									
<b>10520 - SCADA System Communictn Upgrd</b>	<b>70.6%</b>	<b>29.4%</b>	<b>\$93,100</b>	<b>\$32,447</b>	<b>\$0</b>	<b>\$32,447</b>	<b>\$60,653</b>	<b>\$42,821</b>	<b>\$17,832</b>
Upgrade the JPA owned portion of the supervisory control and data acquisition system (SCADA) system to an Ethernet based radio network and provide additional data paths for system redundancy.									
<b>10567 - Progmbble Logic Contrlr Upgrd</b>	<b>70.6%</b>	<b>29.4%</b>	<b>\$2,500,000</b>	<b>\$261,552</b>	<b>\$115,732</b>	<b>\$377,284</b>	<b>\$2,122,716</b>	<b>\$1,498,637</b>	<b>\$624,079</b>
Replace obsolete programmable logic controllers and upgrade other electrical equipment at Tapia.									
<b>10619 - Summer Season 2013 TMDL Compln</b>	<b>70.6%</b>	<b>29.4%</b>	<b>\$2,937,375</b>	<b>\$438,056</b>	<b>\$0</b>	<b>\$438,056</b>	<b>\$2,499,319</b>	<b>\$1,764,519</b>	<b>\$734,800</b>
Construction of a 1MGD "side stream" treatment facility at Tapia to treat stream flow augmentation discharges to the 2013 TMDL limits of 1 mg/L total nitrogen and 0.1 mg/L total phosphorous. The cost estimate is based on membrane technology.									
<b>10635 - PURE WATER PROJECT</b>	<b>70.6%</b>	<b>29.4%</b>	<b>\$7,648,654</b>	<b>\$212,098</b>	<b>\$0</b>	<b>\$212,098</b>	<b>\$7,436,556</b>	<b>\$5,250,209</b>	<b>\$2,186,347</b>
This project funds preliminary studies, outreach, CEQA analysis, preliminary design and final design. Project 10637 Facility Siting Study was completed in prior year for \$180,777. Project 10650 Land Acquisition was completed in prior year for \$2,109,359 Project 10636 Mixing and Dilution Study was completed in prior year for \$337,500									
<b>10665 - Cordillera Tank Rehab</b>	<b>70.6%</b>	<b>29.4%</b>	<b>\$1,201,267</b>	<b>\$0</b>	<b>\$39,879</b>	<b>\$39,879</b>	<b>\$1,161,388</b>	<b>\$819,940</b>	<b>\$341,448</b>
Rehabilitation including interior and exterior coating, valve and appurtenance upgrades and replacements, restoration of deteriorated asphalt, and work to ensure up-to-date compliance for safety and water quality equipment.									
<b>10668 - RLV Storm Wtr Divsn Strctr Rpl</b>	<b>70.6%</b>	<b>29.4%</b>	<b>\$146,802</b>	<b>\$3,746</b>	<b>\$0</b>	<b>\$3,746</b>	<b>\$143,056</b>	<b>\$100,998</b>	<b>\$42,058</b>
Replacement of the two storm water diversion structures at the Rancho Las Virgenes Composting Facility. Increase the size and length of the farm field discharge pipeline.									
<b>10669 - Dev Tour Seating Area @ Tapia</b>	<b>70.6%</b>	<b>29.4%</b>	<b>\$25,000</b>	<b>\$14,035</b>	<b>\$0</b>	<b>\$14,035</b>	<b>\$10,965</b>	<b>\$7,741</b>	<b>\$3,224</b>
Develop tour seating area at Tapia adjacent to the control building									
<b>10680 - RLV Digester Cleaning &amp; Repair</b>	<b>70.6%</b>	<b>29.4%</b>	<b>\$2,856,488</b>	<b>\$1,311,525</b>	<b>\$294,069</b>	<b>\$1,605,594</b>	<b>\$1,250,894</b>	<b>\$883,131</b>	<b>\$367,763</b>
Clean out and make all necessary repairs to digesters #2. the scope of repairs is based on the recently completed rehabilitation of digester # 1. Additional appropriation \$714,379 approved by JPA Board 12/9/19, Item 6C									
<b>10688 - Rancho Solar Gen.-Ph II</b>	<b>70.6%</b>	<b>29.4%</b>	<b>\$2,167,055</b>	<b>\$460,586</b>	<b>\$16,204</b>	<b>\$476,790</b>	<b>\$1,690,265</b>	<b>\$1,193,327</b>	<b>\$496,938</b>
Rancho Solar Generation Project Phase II: Service Agreement for Wholesale Distribution Service and Rule 21 Generator Interconnection Agreement Reimbursable expense of an interconnection facility.									

**Job # - Description**

<b>LV %</b>	<b>TWSD %</b>	<b>Total Project Appropriations</b>	<b>Prior Year Expenditures</b>	<b>Current Year Expenditures</b>	<b>Total Project Expenditures</b>	<b>Project Balance</b>	<b>LV Balance</b>	<b>TWSD Balance</b>
-------------	---------------	-------------------------------------	--------------------------------	----------------------------------	-----------------------------------	------------------------	-------------------	---------------------

**Multi-Year Projects**

<b>10689 - WoolseyFire Rpr - Rancho</b>	<b>70.6%</b>	<b>29.4%</b>	<b>\$1,989,455</b>	<b>\$284,451</b>	<b>\$22,012</b>	<b>\$306,463</b>	<b>\$1,682,992</b>	<b>\$1,188,192</b>	<b>\$494,800</b>
---	--------------	--------------	--------------------	------------------	-----------------	------------------	--------------------	--------------------	------------------

Woolsey Fire Facility Repair. Appropriation of \$46,955 for engineering design and support services during construction approved by JPA Board 3/28/2019, Item 6E.

<b>10692 - WoolseyFire Rpr-JPA Facilities</b>	<b>70.6%</b>	<b>29.4%</b>	<b>\$878,612</b>	<b>\$3,897</b>	<b>\$0</b>	<b>\$3,897</b>	<b>\$874,715</b>	<b>\$617,549</b>	<b>\$257,166</b>
---	--------------	--------------	------------------	----------------	------------	----------------	------------------	------------------	------------------

Woolsey Fire Facility Repair. Appropriation of \$46,112 for engineering design and support services during construction approved by JPA Board 3/28/2019, Item 6E.

<b>10702 - Tapia Efflnt P/S Feeder Reloc</b>	<b>70.6%</b>	<b>29.4%</b>	<b>\$100,000</b>	<b>\$0</b>	<b>\$0</b>	<b>\$0</b>	<b>\$100,000</b>	<b>\$70,600</b>	<b>\$29,400</b>
--	--------------	--------------	------------------	------------	------------	------------	------------------	-----------------	-----------------

Remove or abandon in place existing 4160 volt feeders currently suspended from the top slab of the Effluent Pump Station wet well, underneath the existing MCCs. Perform electrical design and replace the overhead 4160 volt feeders.

<b>Total Multi-Year Projects</b>			<b>\$22,543,808</b>	<b>\$3,022,393</b>	<b>\$487,896</b>	<b>\$3,510,289</b>	<b>\$19,033,519</b>	<b>\$13,437,664</b>	<b>\$5,595,855</b>
----------------------------------	--	--	---------------------	--------------------	------------------	--------------------	---------------------	---------------------	--------------------

**Projects on Hold**

<b>10661 - A/B Bus Electrical Modificatn</b>	<b>70.6%</b>	<b>29.4%</b>	<b>\$100,000</b>	<b>\$0</b>	<b>\$0</b>	<b>\$0</b>	<b>\$100,000</b>	<b>\$70,600</b>	<b>\$29,400</b>
--	--------------	--------------	------------------	------------	------------	------------	------------------	-----------------	-----------------

Study the feasibility of reconfiguring the Tapia electrical switch gear and then hire electrical team to make the modifications.

<b>Total Projects on Hold</b>			<b>\$100,000</b>	<b>\$0</b>	<b>\$0</b>	<b>\$0</b>	<b>\$100,000</b>	<b>\$70,600</b>	<b>\$29,400</b>
-------------------------------	--	--	------------------	------------	------------	------------	------------------	-----------------	-----------------

<b>Totals</b>			<b><u>\$22,643,808</u></b>	<b><u>\$3,022,393</u></b>	<b><u>\$487,896</u></b>	<b><u>\$3,510,289</u></b>	<b><u>\$19,133,519</u></b>	<b><u>\$13,508,264</u></b>	<b><u>\$5,625,255</u></b>
---------------	--	--	----------------------------	---------------------------	-------------------------	---------------------------	----------------------------	----------------------------	---------------------------

<b>Totals: Las Virgenes MWD</b>			<b><u>\$15,986,528</u></b>	<b><u>\$2,133,809</u></b>	<b><u>\$344,455</u></b>	<b><u>\$2,478,264</u></b>	<b><u>\$13,508,264</u></b>		
---------------------------------	--	--	----------------------------	---------------------------	-------------------------	---------------------------	----------------------------	--	--

<b>Totals: Triunfo Water and Sanitation District</b>			<b><u>\$6,657,280</u></b>	<b><u>\$888,584</u></b>	<b><u>\$143,441</u></b>	<b><u>\$1,032,025</u></b>	<b><u>\$5,625,255</u></b>		
--	--	--	---------------------------	-------------------------	-------------------------	---------------------------	---------------------------	--	--

December 7, 2020 JPA Board Meeting

TO: JPA Board of Directors

FROM: Facilities & Operations

**Subject : Carbon Tower Carbon Replacement: Authorization of Purchase Order**

**SUMMARY:**

One of the routine maintenance projects included in the budget is for the replacement of granular activated carbon in the carbon towers that are used for odor control at the Tapia Water Reclamation Facility and LVMWD Lift Station Nos. 1 and 2. There are four carbon towers at Tapia's headworks facility and three carbon towers at the primary sedimentation tanks. These towers need to have regular carbon replacement. For Fiscal Year 2020-21, two primary carbon towers (6,000 lbs. each) and one headworks carbon tower (18,000 lbs.) are scheduled for replacement. Carbon life expectancy is approximately one year for the primary towers and approximately two years for the headworks towers. Additionally, there is a 600-lb. carbon tower at each of LVMWD's lift stations that needs carbon replacement annually. All replaced carbon is removed and regenerated by the vendor.

Staff recommends issuing a purchase order to Karbonous, Inc., formerly Prominent Systems, Inc., as the low bidder for the work. The bid amount submitted by Karbonous is \$1,747 less than last year's. Karbonous, Inc., has performed this service satisfactorily in the past and was recently awarded the Tapia Teritary Filter Media Replacement Project.

**RECOMMENDATION(S):**

Authorize the Administering Agent/General Manager to issue a purchase order to Karbonous, Inc., in the amount of \$39,876.90, for carbon tower media replacement at the Tapia Water Reclamation Facility and Lift Station Nos. 1 and 2.

**FISCAL IMPACT:**

Yes

**ITEM BUDGETED:**

Yes

**FINANCIAL IMPACT:**

The total cost of this action is \$39,876.90. Carbon replacement at the Tapia Water Reclamation Facility is a JPA expense and will be allocated 70.6% to LVMWD and 29.4% to



Triunfo Water and Sanitation District. Carbon replacement at Lift Station Nos. 1 and 2 is an LVMWD-only expense. Sufficient funding for the work is available in the adopted Fiscal Year 2020-21 JPA and LVMWD Budgets.

**DISCUSSION:**

A request for quotes was advertised on the LVMWD website. The following three bids were received for the work:

Novelca, Inc.	\$ 67,232.00
Carbon Activated Corp.	\$ 45,249.00
Karbonous, Inc.	\$ 39,876.90

Replacement of the activated carbon media reduces odors at the facilities and minimizes that potential of nuisances for neighboring properties.

Prepared by: Brett Dingman, Water Reclamation Manager

December 7, 2020 JPA Board Meeting

TO: JPA Board of Directors

FROM: Facilities & Operations

---

**Subject : Sewer System Management Plan: Approval and Recertification**

---

**SUMMARY:**

As required by the State Water Resources Control Board (SWRCB), a Sewer System Management Plan (SSMP) for the JPA's wastewater collection system was developed, approved and certified by the JPA Board on November 3, 2014. The SWRCB requires that SSMPs be updated and recertified every five years. Staff completed the 2020 update to the SSMP, which is presented to the JPA Board for approval and recertification.

**RECOMMENDATION(S):**

Approve the 2020 Sewer System Management Plan, JPA Report No. 2797.00; and authorize the Administering Agent/General Manager, or his designee, to recertify and submit the updated plan to the State Water Resources Control Board.

**FISCAL IMPACT:**

No

**ITEM BUDGETED:**

No

**FINANCIAL IMPACT:**

There is no financial impact associated with this action.

**DISCUSSION:**

To reduce sanitary sewer overflows (SSOs) and provide a consistent, statewide regulatory approach to address SSOs, the SWRCB adopted Statewide General Waste Discharge Requirements for Sanitary Sewer Systems, Water Quality Order No. 2006-0003-DWQ, on May 2, 2006. The Order requires public agencies that own or operate sanitary sewer systems to develop and implement an SSMP. On September 9, 2013, the Order was amended with Order No. 2013-0058-EXEC to address failures in the reporting of SSOs and development of Emergency Response Plans.

The JPA SSMP provides information on the operation and maintenance, design and performance, and capacity evaluation of the sewer collection system. The plan also addresses training of staff and includes an emergency response plan for SSOs. The SSMP was originally developed for the JPA's wastewater collection system in 2009. Updates of the plan were completed in 2011 and 2014. The new version of the SSMP includes updated information for key personnel and a summary of collection system maintenance and capital improvement activities.

Prepared by: Jim Korkosz, Facilities Manager

**ATTACHMENTS:**

JPA Sanitary Sewer Management Plan

**Sewer System Management Plan (SSMP)**

**For the**

**Las Virgenes- Triunfo**

**Joint Powers Authority**

Trunk Sewer system

DRAFT

November 24, 2020

11/30/2020

## Table of Contents

1.1	Introduction .....	1
1.2	Plan and Schedule .....	2
1.3	Goals.....	2
2.0	Organization.....	3
3.0	Legal Authority .....	5
4.0	Operation and Maintenance .....	6
4.1	Mapping .....	6
4.2	Preventive Maintenance Program .....	6
4.3	Rehabilitation and Replacement Program .....	8
4.4	Inspection Program .....	8
4.5	Staff Training.....	8
4.6	Equipment and Parts Inventory .....	9
5.0	Design and Performance.....	9
5.1	Design Standards.....	9
5.2	Inspection and Testing Standards .....	9
6.0	Overflow Emergency Response Plan .....	9
7.0	Fat, Oils & Grease Control Program.....	10
8.0	System Evaluation and Capacity Assurance Plan .....	12
9.0	Monitoring, Measurement, and Program Modification.....	13
10.0	SSMP Audits .....	14
11.0	Communication Program.....	14
12.0	Final SSMP .....	14
13.0	SSMP Recertification .....	15

Appendix A - SSMP Implementation Schedule

Appendix B - Sanitary Sewer Overflow Incident Report

Appendix C – State Waste Discharge Requirements and Chain of Communication  
Flow Chart/ Emergency Response Plan

Appendix D – GIS Map Manhole  
Sewer Map

## 1.1 Introduction

Sanitary sewer systems experience periodic failures resulting in discharges that may affect waters of the state. There are many factors (including factors related to geology, design, construction methods and materials, age of the system, population growth, and system operation and maintenance), which affect the likelihood of a sanitary sewer overflow (SSO). Major specific causes of SSOs include: grease blockages, root blockages, sewer line flood damage, manhole structure failures, vandalism, pump station mechanical failures, power outages, excessive storm or ground water inflow/infiltration, debris blockages, sanitary sewer system age and construction material failures, lack of proper operation and maintenance, insufficient capacity and contractor-caused damages. Many SSOs are preventable with adequate and appropriate facilities, source control measures and operation and maintenance of the sanitary sewer system.

SSOs often contain high levels of suspended solids, pathogenic organisms, toxic pollutants, nutrients, oxygen-demanding organic compounds, oil and grease and other pollutants. SSOs may cause a public nuisance, particularly when raw untreated wastewater is discharged to areas with high public exposure, such as streets or surface waters used for drinking, fishing, or body contact recreation. SSOs may pollute surface or ground waters, threaten public health, adversely affect aquatic life, and impair the recreational use and aesthetic enjoyment of surface waters.

To provide a consistent, statewide regulatory approach to address SSOs, the State Water Resources Control Board (State Water Board) adopted Statewide General Waste Discharge Requirements (WDRs) for Sanitary Sewer Systems, Water Quality Order No. 2006-0003-DWQ (Sanitary Sewer Order) on May 2, 2006. The Sanitary Sewer Order requires public agencies that own or operate sanitary sewer systems to develop and implement sewer system management plans and report all SSOs to the State Water Board's online SSO database. On September 9, 2013, an amendment was made to the sanitary Sewer Order. Order 2013-0058-EXEC was issued on September 9, 2013 to address issues with reporting failures and the development of Emergency Response Plans.

All public agencies that own or operate a sanitary sewer system that is comprised of more than one mile of pipes or sewer lines which convey wastewater to a publicly owned treatment facility must apply for coverage under the Sanitary Sewer Order.

To facilitate proper funding and management of sanitary sewer systems, each applicant who applied for coverage under the Sanitary Sewer Order must develop and implement a system-specific Sewer System Management Plan (SSMP). To be effective, a SSMP must include provisions to provide proper and efficient management, operation, and maintenance of sanitary sewer systems, while taking into consideration risk management and cost benefit analysis.

Additionally, an SSMP must contain a spill response plan that establishes standard procedures for immediate response to an SSO in a manner designed to minimize water quality impacts and potential nuisance conditions. Las Virgenes Municipal Water District (LVMWD or District) acts as the Administrating Agent of the JPA and implements the SSMP. The JPA SSMP will address the following elements:

1. Goal
2. Organization
3. Legal Authority
4. Operation and Maintenance Program
5. Design and Performance Provisions
6. Overflow Emergency Response Plan
7. Fats, Oils, and Grease (FOG) Control Program
8. System Evaluation and Capacity Assurance Plan
9. Monitoring, Measurement, and Program Modifications
10. SSMP Program Audits
11. Communication Program
12. Final SSMP

## **1.2 Plan and Schedule**

Both the SSMP and the program to implement the SSMP must be self-certified by the applicant (JPA) every five years to be in compliance with the requirements set forth. The last SSMP was completed in 2014; therefore, it must be presented to the governing board for recertification at a public meeting by the end of 2020.

## **1.3 Goals**

**The Goals of the Las Virgenes SSMP are as follows:**

- a. To properly manage, operate, and maintain all portions of the Agency's wastewater collection system.
- b. To provide adequate capacity to convey the peak wastewater flows.
- c. To minimize the frequency of SSOs.
- d. To safeguard public health and the environment by mitigating the impacts that are associated with any SSO that may occur.
- e. To protect and extend the useful life of our sanitary sewer investment through diligent planning, engineering, operation and maintenance.

## 2.0 Organization

The organization chart for the management, capital improvement, operation and maintenance of LVMWD sewer system is shown below. The titles, names and phone numbers of staff are shown below.

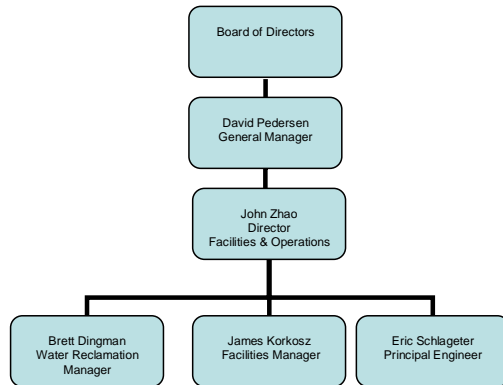

### Board of Directors:

To provide District policy and budgetary approval for the overall operation of the District

### David Pedersen, General Manager, (818) 251-2100

Under policy direction of the Board of Directors, the General Manager serves as the chief executive of the District implementing Board policy. The General Manager determines and executes administrative policies through subordinate managers and is responsible for operations and staffing of the District as prescribed by the Board, including planning and design of facilities, construction, operation and maintenance of facilities and the administration of the business affairs of the District. The General Manager supervises all District employees through subordinate managers, manages the employer/employee relations of the District and works closely with Legal/Audit advisors.

### John Zhao, Director of Facilities and Operation, (818) 251-2100

Under administrative direction of the General Manager, the Director of Facilities and Operations plans, organizes and directs the maintenance, operation, modification and improvements of the water reclamation system and the trunk sewers and facilities maintenance for the District. The Director of Facilities and



Operations exercises administrative and technical supervision over all department personnel through division managers and operation specialists.

**Brett Dingman, Water Reclamation Manager, (818) 251-2100**

Under general direction of the Director of Facilities and Operations, the Water Reclamation Manager is responsible for a variety of wastewater collection, treatment, disposal and reclamation services and activities. This includes operation of all water reclamation functions, supervision of assigned employees, coordination of District maintenance and other work efforts both within the department and in other departments. Oversight responsibilities include quality control, laboratory services, development and implementation of continuous improvement programs, employee supervision, scheduling and budget assistance to the department director.

**James Korkosz, Facilities Manager, (818) 251-2100**

Under general direction of the Director of Facilities and Operations, the Facilities Manager plans and directs the maintenance of all District facilities including the trunk sewer system and water reclamation facility, and the operations and maintenance of the potable water distribution and treatment systems.

**Eric Schlageter, Principal Engineer, (818) 251-2100**

Under general direction of the Director of Engineering and External Affairs, the Principal Engineer acts as the engineering division head coordinating and supervising all engineering activities including special projects, design, construction, and regulatory compliance. Manages and coordinates complex sewer system engineering projects; provides technical guidance and supervision to District staff, contractors, consultants, and developers, and works closely with other District managers to ensure that engineering needs of the entire sewer system are being met.

**SSO reporting and Chain of Communication**

A Sanitary Sewer Overflow Incident Report form is attached as Appendix B. State Water Discharge Requirements and Chain of Communication Flow Chart (Appendix C) is developed to assist District staff in quickly identifying and communicating with internal staff and outside agencies when a Sanitary Sewer overflow is reported.

**Responsibility for SSMP Implementation**

The General Manager is responsible for implementing and maintaining all elements of the SSMP.

### 3.0 Legal Authority

**Requirement:** Each Applicant must demonstrate, through sanitary sewer system use ordinances, service agreements, or other legally binding procedures, that it possesses the necessary legal authority to:

- a. Prevent illicit discharges into its sanitary sewer system, including I/I from satellite wastewater collection systems and laterals, storm water, unauthorized debris, etc.

*Triunfo Sanitation District within Ventura County is a Joint Power's Authority (JPA) partner with LVMWD in wastewater and recycled water service. The JPA operates only the trunk sewer system, not the collector sewers within the service area. Local collectors are operated by the sewer maintenance division of Los Angeles County Department of Public Works and are tributary to the district's trunk sewer system. The JPA also operates and maintains the Tapia Water Reclamation Facility, with a design capacity of 16.1 million gallons per day.*

*The District's Title 5-Sanitation Ordinance provides for the terms and conditions of District sewer service. This title is also enacted for the purpose of establishing pretreatment regulations and is intended to prevent the introduction of pollutants into the District's treatment facilities.*

*In most cases, a sanitation customer is connected to the District's trunk sewer through a collector sewer owned, operated and maintained by the Los Angeles County Consolidated Sewer Maintenance district. Accordingly, the "County of L.A. 1984 Plumbing Code Title 28 of the L.A. County Code, Ordinance No. 2269", as amended, and the "Sanitary Sewer and Industrial Waste Section, Title 20 of the Los Angeles County Code, Ordinance No. 6130", as amended, insofar as they do not conflict with the provisions set forth herein, are hereby adopted by this reference.*

- b. Require proper design and construction of sewers and connections.

*Las Virgenes Municipal Water District has its Standard Plans and Specifications for the construction of trunk sewer and sewer manholes. The district's specifications by reference incorporate the Standard Plans and Specifications for Public Works Construction (Green Book), which helps insure proper design and construction of sewer facilities.*

*Title 5-3.205 – Design and Construction Standards: Lateral Connections to a Trunk Sewer*

*Title 5-3.206 – Design and Construction Standards: Collector Connections to a Trunk Sewer*

*Title 5-3.207 – Design and Construction Standards: Additional requirements for Industrial waste connections*

- c. Ensure access for maintenance, inspection and repairs to publicly owned portions of laterals.

N/A

- d. Limit the discharge of FOG and other debris that may cause blockages.

*Title 5-4.205 - Local Limits < 100 mg/l Oil and Grease*

- d. Enforce violations of its sewer ordinances.

*Title 5-4.306 Public Notification of Violations  
Title 5-4.308 More Stringent Limitations*

#### **4.0 Operation and Maintenance**

Requirement: The SSMP must include those elements listed below that are appropriate and applicable to the Applicant's system.

##### **4.1 Collection System Map**

Requirement: Each wastewater collection system agency shall maintain up-to-date maps of its wastewater collection system facilities, showing all gravity line segments and manholes, pumping facilities, pressure pipes and valves, and applicable storm water pumping and piping facilities.

*See Appendix D for GIS Map for manholes and Sewer Map*

##### **4.2 Preventive Operation and Maintenance**

Requirement: Describe routine preventive operation and maintenance activities by staff and contractors, including a system for scheduling regular maintenance and cleaning of the sanitary sewer system with more frequent cleaning and maintenance targeted at known problem areas. The Preventive Maintenance (PM) program should have a system to document scheduled and conducted activities, such as work orders.

*All of the approximately sixty miles of trunk sewers have been logically split into five reaches to accomplish a 5-year inspection/cleaning cycle. Each year approximately twenty percent of the trunk sewers will be inspected visually or by video camera. The video is reviewed and utilized as both a quality control checks and to document the condition of the trunk sewer. Areas identified by the video as needing attention including cleaning, repairs, or replacement will be addressed. Also, following this procedure, maintenance issues related to the maintenance access cover, ring, stack, and bench are noted and this work is scheduled.*

*On a regular and routine basis, all elevated sewer lines and sewer crossings are inspected. Items included during inspection as appropriate include grouting, painting, inspection of piers, guards, and access points including rings, covers, and hatches. Also, immediately subsequent to periods of heavy rain and earth movement activities these structures are inspected. Many sewer crossings are in remote locations requiring some type of brush and vegetation maintenance and removal. All work orders are initiated by staff. Some work is performed by in-house staff and some is contracted.*

*Staff typically responds to all reported sanitary sewer overflows. Many of the smaller community sewers are owned, operated, and maintained by the local jurisdiction District staff will take appropriate action if first to respond. These actions typically include notifying the affected agency. District personnel respond to and maintain all LVMWD owned and operated trunk sewer activities. Odor complaints are handled in a similar manner.*

*The District also contracts out three sewer flow metering stations on sewers tributary to the trunk sewer system.*

*The District must "lift" (pump) sewage from the eastern most reaches over the foothills in a westward direction to the District's gravity sewer system. In order to accomplish this, there are two sewer lift stations operating in a series fashion to overcome the "head" or vertical elevation created by the foothills.*

*These two lift stations are very similar in design and operation. Each station incorporates a small wet well which supplies sewage to a combination of three parallel centrifugal pumps located in the pumping area of the lift station immediately adjacent to the wet well. The three pumps in each lift station are automatically controlled by the SCADA system's PLC. Normally one pump is required for daily operation. During peak flows and/or rain events, two pumps may operate for a period of time. The third pump serves as a back up.*

*There is also an emergency diesel generator connected to the power grid of each lift station. In the event of a power failure by the electrical utility, Southern California Edison, an automatic transfer switch operates and powers the lift station from the emergency diesel generator.*

*Regular inspections are performed at the lift stations by the operations staff located at the Tapia Reclamation Facility. The collection systems technician and the maintenance staff perform preventive and corrective maintenance at the lift stations. There are many preventive maintenance tasks performed on a routine basis. There are daily, weekly, monthly, quarterly, semi-annual, and annual inspection and maintenance activities. Many of these activities are assigned by the District's AMMS or computerized maintenance management system. Examples of these include exhaust fan inspection, ambient air monitoring*

*equipment inspection and calibration, oil changes on the lift station's pumps and air compressor. Electrical panels and other equipment are routinely inspected and maintained, these include; sump pump inspection and wet well inspection. Wet well inspection and maintenance includes routine cleaning and inspection of level control devices. The emergency diesel generators are regularly maintained by both in-house staff as well as by various vendors, depending on the work involved. All corrective work identified during operation and routine inspection is noted and scheduled for repair typically through the AMMS CMMS. All emergency type work is immediately performed on an as needed basis.*

#### **4.3 Rehabilitation and Replacement Plan**

Requirement: Develop a rehabilitation and replacement plan to identify and prioritize system deficiencies and implement short-term and long-term rehabilitation actions to address each deficiency. The program should include regular visual and TV inspections of manholes and sewer pipes, and system for ranking the conditions of sewer pipes that are at risk of collapse or prone to more frequent blockages due to pipe defects. Finally, the rehabilitation and replacement plan should include a capital improvement plan that addresses proper management and protection of the infrastructure assets. The plan shall include a time schedule to implement a short- and long-term plan plus a schedule for developing the funds needed for the capital improvement plan.

*The district's Infrastructure Investment Plan includes total of \$1,110,000 for Sanitation Construction and Sanitation Replacement.*

#### **4.4. Inspection Program**

Requirement: Program for regular visual and video inspection of the system. Funds in the amount of \$35,000 are budgeted annually. See Section 8.0 for a list of inspections which have occurred since 2010.

See 4.2

#### **4.5 Staff Training.**

Requirement: Provide training on a regular basis for staff in sanitary sewer system operations and maintenance, and require contractors to be appropriately trained.

*The maintenance and operation staff and inspectors attend California Water Environmental Agency (CWEA) trainings. Staff is also required to participate in CWEA or SWRCB certification program.*

*The District has in place a construction crew for emergency response.*

*The district in-house trainings include but not limited to Confined Space Entry Training Certification, First Aid/CPR, Traffic Control Certification, Lock-out/Tag-out Certification, or other safety related trainings the district deems necessary.*

#### **4.6 Contingency Equipment and Replacement Inventories**

Requirement: Provide equipment and replacement part inventories, including identification of critical replacement parts.

*See 4.2*

#### **5.0 Design and Performance**

##### **5.1 Standards for Installation, Rehabilitation and Repair**

Requirement: The SSMP must identify design and construction standards and specifications for the installation of new sanitary sewer systems, pump stations and other appurtenances; and for the rehabilitation and repair of existing sanitary sewer systems.

*LVMWD has its Standard Plans and Specifications for the design and construction of trunk sewer and sewer manholes. The district's specifications by reference incorporate the Standard Plans and Specifications for Public Works Construction (Green Book), which helps insure proper design and construction of sewer facilities.*

##### **5.2 Standards for Inspection and Testing of New, Rehabilitated, and Repaired Facilities**

Requirement: The SSMP must identify the procedures and standards for inspecting and testing the installation of new sewers, pumps, and other appurtenances and for rehabilitation and repair projects.

*LVMWD provides inspection which follows the district standard and Green book during the construction of sewer facilities to ensure proper installation for maximum life expectancy. The work is not placed into service and accepted by the Board of Directors until inspection and testing are completed.*

##### **6.0 Overflow Emergency Response Plan**

Requirement: Each Applicant shall develop and implement an overflow emergency response plan that identifies measures to protect public health and the environment. At a minimum, this plan must include the following:

- a. Proper notification procedures so that the primary responders and regulatory agencies are informed of all SSOs in a timely manner;

- b. A program to ensure an appropriate response to all overflows;
- c. Procedures to ensure prompt notification to appropriate regulatory agencies and other potentially affected entities (e.g., health agencies, Regional Water Boards, water suppliers, etc.) of all SSOs that potentially affect public health or reach water of the State in accordance with the MRP. All SSOs shall be reported in accordance with this MRP, the California Water Code, other State Law, and other applicable Regional Water Board WDRs or NPDES permit requirements. The SSMP should identify the officials who will receive immediate notification;
- d. Procedures to ensure that appropriate staff and contractor personnel are aware of and follow the Emergency Response Plan and are appropriately trained;
- e. Procedures to address emergency operations, such as traffic and crowd control and other necessary response activities; and
- f. A program to ensure that all reasonable steps are taken to contain and prevent the discharge of untreated and partially treated wastewater to waters of the United States and to minimize or correct any adverse impact on the environment resulting from the SSOs, including such accelerated or additional monitoring as may be necessary to determine the nature and impact of the discharge.

*See Appendix B - Sanitary Sewer Overflow Incident Report*

*See Appendix C – State Waste Discharge Requirements and Chain of Communications Flow Chart*

## **7.0 Fats, Oil & Grease Control Program**

Requirements: Each Applicant shall evaluate its service area to determine whether a FOG control program is needed. If an Applicant determines that a FOG program is not needed the Applicant must provide justification as to why it is not needed. If FOG is found to be a problem, the Applicant must prepare and implement a FOG source control program to reduce the amount of these substances discharged to the sanitary sewer system. This plan shall include the following as appropriate:

*The Las Virgenes-Triunfo WSD JPA sewer system is comprised of trunk line sewers and not collector pipelines which are owned and operated by Los Angeles County and Cities within the District boundaries. Because of this, the Cities and Counties are responsible for any FOG programs since they permit the connections.*

- a. An implementation plan and schedule for a public education outreach program that promotes proper disposal of FOG;

N/A

- b. A plan and schedule for the disposal of FOG generated within the sanitary sewer system service area. This may include a list of acceptable disposal facilities and/or additional facilities needed to adequately dispose of FOG generated within a sanitary sewer system service area;

N/A

- c. The legal authority to prohibit discharges to the system and identify measures to prevent SSOs and blockages caused by FOG;

*The District Title 5-4.205 Local Limits < 100 mg/l Oil and Grease*

- d. Requirements to install grease removal devices (such as traps or interceptors), design standards for the removal devices, maintenance requirements, BMP requirements, record keeping and reporting requirements;

N/A

- e. Authority to inspect grease producing facilities, enforcement authorities, and whether the Applicant has sufficient staff to inspect and enforce the FOG ordinance;

N/A

- f. An identification of sanitary sewer system sections subject to FOG blockages and establishment of a cleaning maintenance schedule for each section.

N/A

- g. Development and implementation of source control measures for all sources of FOG discharged to the sanitary sewer system for each section identified in (f) above.

N/A



## 8.0 System Evaluation and Capacity Assurance Plan

**Requirements:** The Applicant shall prepare and implement a capital improvement plan that will provide hydraulic capacity of key sanitary sewer system elements for dry weather peak flow conditions, as well as the appropriate design storm or wet weather event. At a minimum, the plan must include:

- a. Evaluation: Actions needed to evaluate those portions of the sanitary sewer system that are experiencing or contributing to an SSO discharge caused by hydraulic deficiency. The evaluation must provide estimates of peak flows (including flows from SSOs that escape the system) associated with conditions similar to those causing overflow events, estimates of the capacity of key system components, hydraulic deficiencies (including components of the system with limiting capacity) and the major sources that contribute to the peak flows associated with overflow events.

Visual or Video inspection and actions since 2015 were performed as follows:

Year	Sewer Line	Action
2015	D-1, D and E	Inspection No cleaning was required
2016	U1, U2 and U3	Inspection No cleaning was required
2017,2019	C	Inspection 2200' were cleaned
2019	A and B	Inspection No cleaning was required
2020		No cleaning was required

Formatted: Font color: Auto

*The District Sewer Master Plan Update analyzed the existing and increasing capacity in 2014. The current system capacity is able to handle both dry weather and wet weather peak sewer flow, and will meet the requirement for future developments.*

*The District also conducts periodic review and modification to the Master Plan, and incorporates the updates to the District Capital Improvement Program (CIP).*

- b. Design Criteria: Where design criteria do not exist or are deficient, undertake the evaluation identified in (a) above to establish appropriate design criteria; and

N/A

- c. Capacity Enhancement Measures: The steps needed to establish a short- and long-term CIP to address identified hydraulic deficiencies, including prioritization, alternatives analysis, and schedules. The CIP may include increases in pipe size, I/I reduction, increases and redundancy in pumping capacity, and storage facilities. The CIP shall include an implementation schedule and shall identify sources of funding.

*Infrastructure Investment Plan (IIP) FY2020-FY2030. A total of \$11.1 M for Sanitation Construction and Sanitation Replacement of which \$1,110,000.00 is specifically for the sewers and lift stations.*

- d. Schedule: The Applicant shall develop a schedule of completion dates for all portions of the capital improvement program developed in (a) –(c) above. This schedule shall be reviewed and updated consistent with the SSMP review and update requirements as described in Section D.14.

*The District IIP (Infrastructure Investment Plan) is reviewed and updated annually.*

## **9.0 Monitoring, Measurement, and Program Modification**

Requirements: The Applicant shall:

- a. Maintain relevant information that can be used to establish and prioritize appropriate SSMP activities;

*Implementing Information Management Systems - GIS  
Sewer Condition Assessment  
Operation and Maintenance Program – see Section 4.0-4.5  
Overflow Emergency Response – See Section 6.0*

- b. Monitor the implementation and, where appropriate, measure the effectiveness of each element of the SSMP;

*Each year, any plan updates necessary to enhance the SSMP performance are identified and become a part of the following year's IIP (Infrastructure Investment Plan).*

- c. Assess the success of the preventive maintenance program;

*The District conducts routine video inspections throughout the District following in conjunction with cleaning and maintenance program.*

- d. Update program elements, as appropriate, based on monitoring or performance evaluations.

*Annual review of preventive maintenance:*

*On an annual basis, a comprehensive review of the maintenance program and CIP are conducted. The critical sewers are identified, prioritized and scheduled for repair or rehabilitation.*

*See 4.2*

- e. Identify and illustrate SSO trends, including: frequency, location, and volume.

*After integration and conversion of sewer system data into GIS program, GIS serves as a tracking system to plot SSO trends including frequency, location and volume, etc.*

#### **10.0 SSMP Audits**

Requirements: As part of the SSMP, the Applicant shall conduct periodic internal audits, appropriate to the size of the system and the number of SSOs. At a minimum, these audits must occur every two years and a report must be prepared and kept on file. This audit shall focus on evaluating the effectiveness of the SSMP and the Applicant's compliance with the SSMP requirements identified in this subsection (D.13), including identification of any deficiencies in the SSMP and steps to correct them.

*The District will perform an internal evaluation of its compliance every year; recommendations for improvements will be reported to the Board through incorporation into the District's IIP. Maintenance projects are tracked through the District's Automated Maintenance Management System (AMMS).*

#### **11.0 Communications Program**

Requirement: The Applicant shall communicate on a regular basis with the public on the development, implementation and performance of its SSMP. The communication system shall provide the public the opportunity to provide input to the Applicant as the program is developed and implemented. The Applicant shall also create a plan of communication with systems that are tributary and/or satellite to the Applicant's sanitary sewer system.

*The District implements community outreach programs including a Customer Newsletter and Website.*

#### **12.0 Final SSMP**

Requirement: Both the SSMP and the Applicant's program to implement the SSMP must be certified by the Applicant to be in compliance with the requirements set forth above and must be presented to the Applicant's governing board for approval at a public meeting. The Applicant shall certify that the SSMP and subparts thereof, are in compliance with the general WDRs within the timeframes identified in the time schedule provided in subsection D.15, below.

In order to complete this certification, the Applicant's authorized representative must complete the certification portion in the Online SSO Database Questionnaire by checking the appropriate milestone box, printing and signing the automated form, and sending the form to the State Water Board.

*The Final SSMP will be submitted to the Joint Powers Authority Board for approval on November 3, 2014.*

### **13.0 SSMP Recertification**

November 3, 2014  
December 7, 2020

## Appendix A SSMP IMPLEMENTATION SCHEDULE

Task Number	Main Task/Sub-Task	Description	Legal Due Date	Proposed/Actual Completion Date	Responsible Party
<b>A</b>	<b>Application for Coverage</b>	Submit Notice of Intent (NOI) to the state identifying the agency's authorized representative including required permit fee.	<b>11/2/2006</b>	8/8/2006	FO/Operation
<b>B</b>	<b>SSO electronic reporting program</b>	Agency must report all SSOs to the statewide SSO database via the Internet.	<b>Continuous</b>	Continuous	FO/Operation
<b>C</b>	<b>SSMP Development Plan and Schedule</b>	Initial plan on how the agency intends to develop and implement their SSMP.	<b>11/2/2007</b>	10/1/2007 <b>Board Approval</b>	FO/Technical Services
<b>1.0</b>	<b>Goal</b>		<b>11/2/2007</b>	10/1/2007	FO/Operation
1.1	SSMP Goal	State goals for the SSMP			
<b>2.0</b>	<b>2.0 Organizational Structure</b>		<b>11/2/2007</b>	10/1/2007	FO/Operation
2.1	Agency Organizational Structure	Names and staff positions responsible for developing and implementing the SSMP, including the chain of communications for reporting SSOs.		10/1/2007	FO/Operation
<b>3.0</b>	<b>3.0 Legal Authority</b>	Agency's legal authority to operate and maintain its sewage collection system	<b>5/02/2009</b>	4/2/2009	FO/Technical Services

Task Number	Main Task/Sub-Task	Description	Legal Due Date	Proposed/Actual Completion Date	Responsible Party
<b>4.0</b>	<b>4.0 Operation and Maintenance</b>		<b>5/02/2009</b>	4/2/2009	
4.1	Mapping	Up-to-date mapping of the sewage collection system facilities, GPS manhole locations, including appropriate storm water/drainage systems.		4/2/2009	FO/Planning
4.2	Preventive maintenance program	Written description of the preventive maintenance activities the agency employees.		4/2/2009	FO/Facility
4.3	Rehabilitation and replacement program	Short and long-term plan for the rehabilitation or replacement due to system deficiencies including funding (CIP).		4/2/2009	FO/Technical Services
4.4	Inspection program	Program for the regular visual and CCTV inspection of the system.		4/2/2009	FO/Facility
4.5	Staff training	Staff O&M training and assurance that contractors are adequately trained.		4/2/2009	FO
4.6	Equipment and parts inventory	Equipment and parts inventory including the identification of critical replacement parts.		4/2/2009	FO/Facility
<b>5.0</b>	<b>5.0 Design and Performance</b>		<b>8/02/2009</b>	7/2/2009	FO/Technical Services
5.1	Design standards	Design standards for new and rehabilitated systems.		7/2/2009	FO/Technical Services
5.2	Inspection and testing standards	Inspection and testing standards for new and rehabilitated systems.		7/2/2009	FO/Technical Services
<b>6.0</b>	<b>6.0 Overflow Emergency Response Plan</b>	Written procedures defining how the agency responds to SSOs.	<b>5/02/09</b>	4/02/2009	FO/Operation
<b>7.0</b>	<b>7.0 Fats, Oils &amp; Grease Control Program</b>	Legal authority to prevent the discharge of FOG into the system. Program to reduce or eliminate FOG related SSOs.	<b>5/02/09</b>	4/02/2009	FO/Technical Services

<b>Task Number</b>	<b>Main Task/Sub-Task</b>	<b>Description</b>	<b>Legal Due Date</b>	<b>Proposed/Actual Completion Date</b>	<b>Responsible Party</b>
<b>8.0</b>	<b>8.0 System Evaluation and Capacity Assurance Plan</b>	Evaluate those portions of the system that are experiencing capacity related overflows. Establish steps to eliminate capacity related overflows including I&I program, and short and long-term CIP for capacity issues.	<b>8/02/2009</b>	7/2/2009	FO/ Technical Services
<b>9.0</b>	<b>9.0 Monitoring, Measurement, and Program Modifications</b>	Maintain records, monitor and assess the effectiveness of the program and update as necessary.	<b>8/02/2009</b>	7/2/2009	FO/Operation
<b>10.0</b>	<b>10.0 SSMP Audits</b>	Conduct periodic audits, at least every two years, on the SSMP.	<b>Every 2 years</b>		Third Party
<b>11.0</b>	<b>11.0 Communications Program</b>	Develop a public communication program with customers and potential customers that includes the opportunity to provide input during the development, implementation, and performance of its SSMP. If there is a satellite agency connected to the collection system, develop a plan of regular communication with them		7/2/2009	RCPO
<b>12.0</b>	<b>Final SSMP</b>	Final the SSMP document after all elements have been developed and implemented.	<b>8/02/09</b>	7/14/2009 Board Approval	FO/Technical Services
<b>13.0</b>	<b>SSMP Recertification</b>	Recertify as required every 5 years	<b>12/31/2014</b>	11/3/2014 JPA Board Approval	FO/Technical Services
		Recertify as required every 5 years	<b>12/7/2020</b>	12/7/2020 JPA Board Approval	FO

## Appendix B

### SANITARY SEWER OVERFLOW INCIDENT REPORT Specific Details for Receiving SSO Notice

Exact Location \_\_\_\_\_

\_\_\_\_\_

Overflow Date \_\_\_\_\_ Time started \_\_\_\_\_ Ended \_\_\_\_\_

Reported by \_\_\_\_\_ Phone number \_\_\_\_\_

#### Type of Overflow

- Intermittent manhole overflow.  Broken sewer line.  
 Constant manhole overflow.  Sewage odor.  
 Other info: (examples line size, GPS coordinates, MH #) \_\_\_\_\_

\_\_\_\_\_

LV staff receiving initial call \_\_\_\_\_ Time \_\_\_\_\_

LVSSO staff contacted \_\_\_\_\_ Time \_\_\_\_\_

Surface Waters Impacted  Yes  No  > 50,000 gallons to surface water

#### SSO Response Report

SSO site conditions \_\_\_\_\_

\_\_\_\_\_

\_\_\_\_\_

Remedial actions \_\_\_\_\_

\_\_\_\_\_

\_\_\_\_\_

Responsible Agency/Individual \_\_\_\_\_

Contacted parties \_\_\_\_\_

File report with Jacqy Gamble.  
File pictures on \\LV-data\data\Photos\Sewers\your file name here

B-1



**SSO Severity Level**

- < 1,000 gal. total spill/loss
  - 1,000 to 10,000 gal.
  - 10,000 to 100,000 gal.
  - > 100,000 gal.
- Est. flow rate (see pictures in Manual) \_\_\_\_\_  
\_\_\_\_\_

**SSO Category (see Response Flowchart)**

- Category 1
  - Category 2
  - Category 3
  - Private Lateral Sewer Discharge (PLSD)
- LV staff notified \_\_\_\_\_

File report with Jacqy Gamble.  
File pictures on \\Lv-data\data\Photos\Sewers\your file name here

B-2

## Appendix C

### State Waste Discharge Requirements and Chain of Communications Flow Chart/Emergency Response Plan

ELEMENT	REQUIREMENT	METHOD
<b>NOTIFICATION</b> (see section B)	<ul style="list-style-type: none"> <li>• Within 2 hours of becoming aware of any Category 1 SSO <b>greater than or equal to 1,000 gallons</b>, notify the California Emergency Management Agency (Cal EMA) and obtain a notification control number.</li> </ul>	Call Cal EMA at: <b>(800) 852-7550</b>
<b>REPORTING</b> (see section C)	<ul style="list-style-type: none"> <li>• Category 1 SSO: Submit Draft report within 3 business days of becoming aware of the SSO and certify within 15 calendar days of SSO end date.</li> <li>• Category 2 SSO: Submit Draft report within 3 business days of becoming aware of the SSO and certify within 15 calendar days of SSO end date.</li> <li>• Category 3 SSO: Submit Certified report within 30 calendar days of the end of month in which SSO occurred.</li> <li>• SSO Technical Report: Certify within 45 calendar days after the end date of any Category 1 SSO in which 50,000 gallons or greater is spilled to surface waters.</li> <li>• "No Spill" Monthly Certification: Certify that no SSOs occurred within 30 calendar days of the end of the month in which no SSOs occurred.</li> <li>• Collection System Questionnaire: Update and Certify every 12 months.</li> </ul>	Enter data into the California Integrated Water Quality System (CIWQS) Online SSO Database ( <a href="http://ciwqs.waterboards.ca.gov/">http://ciwqs.waterboards.ca.gov/</a> ), certified by enrollee's Legally Responsible Official(s).
<b>WATER QUALITY MONITORING</b> (see section D)	<ul style="list-style-type: none"> <li>• Conduct water quality sampling <b>within 48 hours</b> after initial SSO notification for Category 1 SSOs in which 50,000 gallons or greater is spilled to surface waters. Testing includes Ammonia, Bacti: T &amp; F Colirom &amp; E coli. above and below the spill reach.</li> </ul>	Water quality results are required to be uploaded into CIWQS for Category 1 SSOs in which 50,000 gallons or greater is spilled to surface waters.
<b>RECORD KEEPING</b> (see section E)	<ul style="list-style-type: none"> <li>• SSO event records.</li> <li>• Sanitary Sewer Management Plan (SSMP) implementation and changes/updates to SSMP.</li> <li>• Records to document Water Quality Monitoring for SSOs of 50,000 gallons or greater spilled to surface waters.</li> <li>• Collection system telemetry records if relied upon to document and/or estimate SSO Volume.</li> </ul>	Self-maintained records shall be available during inspections or upon request.

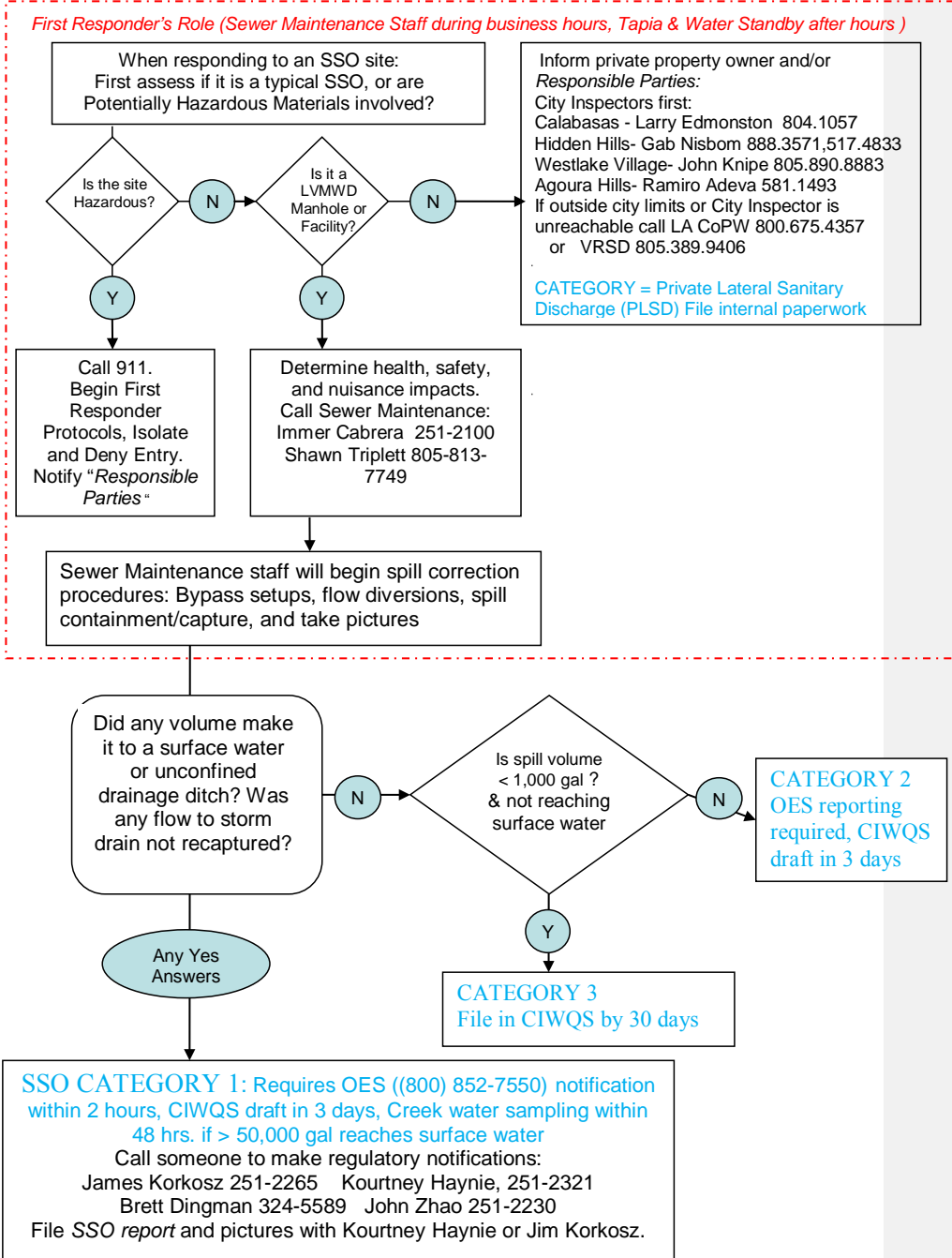

## Las Virgenes Municipal Water District

### Spill Cleanup Contingency Plan/ Overflow Emergency Response Plan

**Requirement:** Each Applicant shall develop and implement an overflow emergency response plan that identifies measures to protect public health and the environment. At a minimum, this plan must include the following:

- a. *Proper notification procedures so that the primary responders and regulatory agencies are informed of all SSOs in a timely manner;*
- b. *A program to ensure an appropriate response to all overflows;*
- c. *Procedures to ensure prompt notification to appropriate regulatory agencies and other potentially affected entities (e.g., health agencies, Regional Water Boards, etc.) of all SSOs that potentially affect public health or reach water of the State in accordance with the MRP. All SSOs shall be reported in accordance with this MRP, the California Water Code, other State Law, and other applicable Regional Water Board WDRs or NPDES permit requirements. The SSMP should identify the officials who will receive immediate notification;*
- d. *Procedures to ensure that appropriate staff and contractor personnel are aware of and follow the Emergency Response Plan and are appropriately trained;*
- e. *Procedures to address emergency operations, such as traffic and crowd control and other necessary response activities; and*
- f. *A program to ensure that all reasonable steps are taken to contain and prevent the discharge of untreated and partially treated wastewater to waters of the United States and to minimize or correct any adverse impact on the environment resulting from the SSOs, including such accelerated or additional monitoring as may be necessary to determine the nature and impact of the discharge.*

See Appendix A – SSMP Implementation Schedule

See Appendix B – Sanitary Sewer Overflow Incident Report

See Appendix C – State Waste Discharge Requirements and Chain of Communications Flow Chart/Emergency Response Plan

**Appendix D**  
**GIS Manhole Map/ Sewer Map**

D-1

December 7, 2020 JPA Board Meeting

TO: JPA Board of Directors

FROM: Engineering and External Affairs

---

**Subject : Pure Water Demonstration Project Sustainability Garden: Authorization of Change Order**

---

**SUMMARY:**

The Urban Water Group was hired in March 2020 to develop website content for each of the signs placed in the Pure Water Demonstration Project Sustainability Garden. As the designers of the garden, the Urban Water Group was particularly well suited for developing the website content for each of the different garden plantings. The original contract was for \$18,660, which was modified by a change order in August 2020. Change Order No. 1, in the amount of \$14,500, was initiated by the District for additional work in the garden to refresh the plantings and replace plants that did not become established or were under performing. The change order also allowed for the website content to be updated based on the new plantings in anticipation of the September 11, 2020 grand opening for the Pure Water Demonstration Project.

Upon completion of the work, it became apparent that additional services were needed to provide signage for the garden and further assist with establishment of the plantings. Contract Change Order No. 2, in the amount of \$26,850, is proposed for approval to support the need for additional support by the Urban Water Group. The change order will bring the revised contract total to \$60,010.

**RECOMMENDATION(S):**

Authorize the Administering Agent/General Manager to approve Change Order No. 2 with the Urban Water Group, in the amount of \$26,850, for additional professional services to support the Pure Water Demonstration Project Sustainability Garden.

**FISCAL IMPACT:**

Yes

**ITEM BUDGETED:**

Yes

**FINANCIAL IMPACT:**

The cost of this action is \$26,850. Sufficient funds are available in the adopted Fiscal Year 2020-21 JPA Budget.

## **DISCUSSION:**

As the designer of the Pure Water Demonstration Project Sustainability Garden, the Urban Water Group is uniquely qualified to recommend changes to the existing plantings in the garden and provide web-based materials to enhance the visitor experience. This work will be particularly important given the limited ability to provide in-person tours of the Pure Water Demonstration Project and Sustainability Garden as a result of the COVID-19 pandemic. As an alternative to in-person tours, staff has been developing an opportunity for the community to still taste the water from the facility as part of a "Taste the Water and Tour the Garden Program".

The work to be performed with Change Order No. 2 will allow the Urban Water Group to assist in the development of additional signage for the garden, which will greatly enhance the visitor experience. Included in this effort are two sign posts that will have six to eight directional arrows on each to route visitors to points of interest. One sign post will be placed on a circular concrete platform on the south side of the garden, directing visitors to different parts of the garden. The other sign post will be placed on the patio outside the Pure Water Demonstration Facility and will show the distance and direction to different sources of water for Southern California. In addition to these signs, six smaller 8.5 x 11-inch signs will be developed for specific topics such as fire defensible space and placed closer to the ground. Finally, plant identification signs that will be approximately 3 x 5 inches will be placed next to plants in the garden. The plant identification signs will include both the common and scientific names of the plants as well as their region of origin. This will allow visitors the immediate satisfaction of identifying the plants without the need to reference a plant list or planting plan.

The change order provides for the development of planting plans for each of the different garden areas that will be added to the website content. These will be colorful representations of where each plant is located in the different garden areas and will be used as a compliment to the plant lists, which have already been completed. When used together, the plant list and planting plan will allow customers to easily identify the locations and types of plants. This will allow visitors the opportunity to mimic the plantings in their own yard or to identify desired plants.

While native and climate-appropriate plants are hardy once established, the establishment period can be tricky. Additionally, pruning and maintaining of these types of plants is different than typical landscaping and requires a greater understanding of experience. To maintain a healthy and attractive plant, more attention needs to be paid to how and when to prune in order to minimize plant loss and decreased vigor. Therefore, the change order also provides for the completion of a maintenance specification manual, which will be used to help train landscapers on how to manage the Sustainability Garden. Additionally, this manual will be placed on the garden website as a reference for the general public.

To help manage the garden during the establishment period, the change order also provides for quarterly visits by the garden designers. These visitations will be conducted with the JPA landscaper to discuss maintenance needs and recommend changes as needed. These visitations will also provide the opportunity to discuss changes in plantings that could be needed as a result of plant mortality or poor establishment. The quarterly site visits will be

performed through Fiscal Year 2022, which will correspond with a typical three-year establishment period for native landscaping.

Prepared by: Dave Roberts, Resource Conservation Manager

**ATTACHMENTS:**

Change Order No. 2 Proposal



Urban Water Group

Contract Change Order 2

Additional for fee tasks

**1.0 Sustainability Garden Maintenance Specifications** – Ongoing maintenance of the sustainability garden will require a specific understanding of the needs of garden plants. The manual will provide maintenance specifications for plants used in the garden including irrigations needs, fertilization, spacing and other unique needs of garden plants. Of particular concern is pruning and thinning instructions that maintain the natural aesthetics of the plants, maximizes ecosystem benefits and assures that plants will be pruned properly and at the right time of year to maintain ongoing plant vigor.

1.1 Document Preparation – contractor shall work with District staff on development of specific content for the document but shall include at a minimum the items listed above and other mutually agreed to by the contractor and the District. The final document shall be in English and will not include a Spanish translation.

1.2 Update Allowance – the contract will allow for one update to the specifications if additional and different plants are added to the garden as part of ongoing maintenance. No work shall be completed on this task without written approval of the District.

**2.0 Planting Plans for Different Garden Areas** – Contractor shall prepare eleven planting plans for different areas of the garden that show the physical location of plants that are currently in each of the planting locations in the garden. The planting plans shall be in full color and visually engaging for garden visitors. Plans will include both the scientific and common names for each plant in the garden area and will be prepared consistent with other efforts to develop website content.

2.2 Update Allowance – the contract will allow for one update to the specifications if additional and different plants are added to the garden as part of ongoing maintenance. No work shall be completed on this task without written approval of the District.

**3.0 Garden Signage Production Consulting** – During initial garden construction, various design elements were modified or delayed based upon difficulty of implementation, cost or competing priorities. Additionally, after completion of the existing garden signs, it was noted that some important garden design topics, such as fire defensible space, were not addressed and/or could be better conveyed as single topic sign. Complement to the topical signage in the garden is a need to better identify individual plant plants without consultation of on-line plant lists and planting plans.

**3.0 Consultation During Sign Fabrication** – contractor shall consult with a sign company selected by the District on the design and fabrication of the following signs:

- Arrow sign posts (2) – one sign post for garden features and another sign post for water sources
- Water Drop Signs (8) – eight sign posts for distribution through the garden that correspond with irrigation levels for different planting types.
- Garden Directory (1) – one garden overview map to be placed on the patio area overlooking the garden.

- Small Topic Signs (6) – develop content and graphics for six topical signs to be placed at appropriate locations in the garden.
- Plant Identification Tags (200) – contractor shall identify plants for individual identification signage as well as the content and design for identification tags including both common and scientific names and region of origin.

3.1 Identify Sign Locations and Observe Installation – contractor shall identify the locations of the signs in a manner easily understood by the sign installers and will be present to observe the installation of the signs.

**4.0 Ongoing Garden Oversight and Consultation** – the establishment period for native gardens can take a few years and will include the need for ongoing maintenance and improvement. The contractor will perform (6) quarterly site visits to monitor the status of the garden, maintenance needs, individual plant health and recommend plantings as needed to replace dead plants and maintain the aesthetic of the garden.

<b>Urban Water Group - Contract Change Order 2</b>				
<b>Rate Sheet</b>				
	<b>Task</b>	<b>Hours</b>	<b>Rate</b>	<b>Total</b>
<b>1. Maintenance Specifications Manual</b>				
	Prepare maintenance specifications manual in English in pdf format	40	150	6000
	Allowance for one update to maintenance manual, as needed	8	150	1200
<b>2. Planting Plans</b>				
	Prepare 11 planting plans in pdf format after garden refresh efforts	63	90	5670
	Allowance for one update to planting plans, as needed	12	150	1800
<b>3. Garden Signage Production Consulting (cost of signage not included)</b>				
	Correspondence and coordination with sign fabrication company selected by the District - review and approve shop drawings for fabrication	8	150	1200
	Identify sign locations and observe installations, 2 site visits @ 2 hours each	4	150	600
	Identify plants for creation of identification signs - including common and scientific names and region of origin for up to 200 signs	12	90	1080
	Observe installations of up to 200 identification signs plus 100 duplicates and validate accuracy of sign placement	8	150	1200
	Develop content and graphics for six topical signs, 8 1/2" x 11" format	30	90	2700
<b>3. Ongoing Consultation and Oversight</b>				
	Six walkthroughs with District staff and landscape contractor, two hours each, every three months	24	150	3600
	Allowance for specifying and locating quarterly plant replacements, as needed (cost of plants not included)	12	150	1800
<b>Total Cost for Contract Change Order</b>				<b>26850</b>

December 7, 2020 JPA Board Meeting

TO: JPA Board of Directors

FROM: Facilities & Operations

---

**Subject : Rancho Solar Generation Project Phase II: Estoppel Certificates**

---

**SUMMARY:**

On November 18, 2020, the Administering Agent/General Manager signed the attached Estoppel Certificates for the Rancho Solar Generation Project Phase II. The two Estoppel Certificates were requested by Morgan Stanley Renewables, Inc., as the bondholder for the project. The documents certify the power purchase and lease agreements with Borrego Solar for the project are both in good standing. Staff and JPA Legal Counsel reviewed the proposed Estoppel Certificates and recommended execution by the Administering Agent/General Manager.

Construction of the 4-megawatt Rancho Solar Generation Project Phase II is now complete. Southern California Edison is scheduled to complete the interconnection of the facility to the power grid and allow for startup testing on December 10, 2020.

**FISCAL IMPACT:**

No

**ITEM BUDGETED:**

No

Prepared by: John Zhao, P.E., Director of Facilities and Operations

**ATTACHMENTS:**

Power Purchase Agreement Estoppel Certificate

Lease Agreement Estoppel Certificate

Estoppel Certificate

November 18, 2020

This Estoppel (as amended, amended and restated, supplemented or otherwise modified from time to time, this “Estoppel”), dated as of November 18, 2020, is delivered by Las Virgenes-Triunfo Joint Powers Authority, (together with its successors, designees and assigns, “Counterparty”) to Las Virgenes Solar 1, LLC, a Delaware limited liability company (together with its successors, designees and assigns, “Project Company”), Morgan Stanley Renewables Inc., a Delaware corporation (together with its successors and assigns, “Investor”), and Fifth Third Bank, National Association, in its capacity as administrative agent (“Agent”) for the lenders (the “Lenders” and, together with Investor and Agent, collectively, the “Reliance Parties”). Capitalized terms used but not otherwise defined herein shall have the respective meanings ascribed to such terms in the Agreement described below.

RECITALS

WHEREAS, Counterparty and Project Company are parties to the Solar Power Purchase Agreement, dated as of April 10, 2019 (as amended, modified or supplemented from time to time, the “Agreement”) in connection with the approximately 4.008 MW solar electric generation facility being developed by Project Company in Calabasas, CA (the “Facility”);

WHEREAS, (i) Investor has agreed to acquire certain membership interests of the direct parent company of Project Company, and (ii) the Lenders have agreed to provide loans to an indirect parent company of Project Company (collectively, the “Investment”);

WHEREAS, the Investment is a tax equity and debt transaction relating to the Facility and each Reliance Party is therefore a Financing Party as defined in the Agreement; and

WHEREAS, pursuant to section 11 (c) of the Agreement, Counterparty has agreed to execute and deliver an estoppel to a Financing Party in connection with any financing with respect to the Facility.

1. Representations and Warranties and Certain Covenants

(a) Counterparty hereby represents and warrants to Project Company and the Reliance Parties as follows:

(1) The execution, delivery and performance of this Estoppel has been duly authorized by Counterparty.

(2) This Estoppel constitutes the legal, valid and binding obligation of Counterparty, enforceable against it in accordance with its terms, except to the extent limited by bankruptcy, insolvency or other similar laws relating to the rights of creditors, or by general principles of equity.

(3) To the actual knowledge of Counterparty, there are not presently any disputes or any legal proceedings between Counterparty and Project Company relating to the Agreement.

(4) The execution, delivery and performance of the Agreement and this Estoppel by Counterparty, and the consummation of the transactions contemplated thereby and hereby, to the actual knowledge of Counterparty, do not and will not require any further authorizations, consents or approvals or filings with any entity or person which have not been obtained or made, or violate or conflict with any provision of any law, regulation, order, permit, license, rule, judgment, injunction, or similar matters or breach any agreement, any material indenture, contract or organizational document presently in effect with respect to or binding on Counterparty or any properties to which Counterparty may be bound.

(5) All government approvals necessary for the execution, delivery and performance by Counterparty of its obligations under the Agreement have been obtained and are in full force and effect, except those governmental approvals routinely obtained during the ordinary course of business during the execution of the Facility.

(6) To the actual knowledge of Counterparty, there is no litigation, action, suit, proceeding or investigation at law or in equity relating to the Agreement by or before any governmental authority, arbitral tribunal or other body now pending against Counterparty or, to the actual knowledge of Counterparty, threatened against or affecting Counterparty that (i) questions the validity, binding effect or enforceability hereof or of the Agreement against Counterparty, or any action taken or to be taken pursuant hereto or thereto or any transactions contemplated hereby or thereby, (ii) could have a materially adverse effect on the performance of the obligations hereof or of the Agreement by Counterparty or the condition (financial or otherwise), business, or operation of Counterparty; or (iii) could modify or otherwise adversely affect any required approvals, filings or consents which have previously been obtained or made.

(7) Except for the amendments listed in Schedule I herein, the Agreement has not been amended, supplemented or modified since the date of execution of the Agreement.

(8) This Estoppel, the Agreement and the Amended and Restated Cost Reimbursement Agreement, dated September 6, 2019, are the only contracts between Project Company and Counterparty.

(9) Counterparty has not transferred or assigned any interest in the Agreement or, with the exception of the assignments listed in Schedule II herein, received notice of any assignment by Project Company of the Agreement.

(10) To the actual knowledge of Counterparty, neither Party is in default of any of its obligations under the Agreement or has breached any representation, warranty or covenant under the Agreement.

(11) To Counterparty's knowledge, (a) no event of force majeure exists under the Agreement and (b) no event or condition exists which, with the passage of time or the giving of notice or both, would constitute a default or breach by either party or enable either party to terminate or suspend its obligations under the Agreement.

(12) All payments due to or from Project Company under the Agreement through the period ending on the date hereof have been paid.

(b) Counterparty hereby further acknowledges and agrees that:

(1) Project Company, each Reliance Party, and their respective successors and assigns, and their potential equity investors, lenders and participants, and their respective successors and assigns shall be entitled to rely upon this certification by Counterparty.

(2) All milestones and conditions that were required to be completed or satisfied by Project Company under the Agreement prior to the date hereof have been completed or satisfied. Nothing in this subclause (2) will be deemed to be a waiver of the Counterparty's rights under the Agreement.

(3) Counterparty agrees to simultaneously deliver to Investor and Agent, at the addresses provided on Schedule III hereto, a copy of any material notice, including without limitation default or termination notices, delivered to Project Company under the Agreement. Counterparty agrees that no right of Counterparty to terminate or suspend its obligations under the Agreement (a "Termination Event") will become effective under the Agreement unless it provides written notice thereof to Investor and Agent, and neither Investor nor Agent have cured such Termination Event within the same cure period afforded to Project Company under the Agreement. Any curing of or attempt to cure any Termination Event shall not be construed as an assumption by either Investor or Agent of any covenants, agreements or obligations of Project Company under or in respect of the Agreement.

2. Governing Law; Waiver of Jury Trial

THIS ESTOPPEL SHALL BE GOVERNED BY AND CONSTRUED UNDER THE LAWS OF THE STATE OF NEW YORK AND WITHOUT REFERENCE TO CONFLICTS OF LAWS PRINCIPLES.

3. Successors and Assigns

This Estoppel shall be binding upon and inure to the benefit of the Project Company, each Reliance Party and their permitted successors and assigns (which assigns, in the case of any Reliance Party, shall be any nominee or designee of such entity).

[REMAINDER OF PAGE INTENTIONALLY LEFT BLANK]

IN WITNESS WHEREOF, the undersigned has duly executed this Estoppel as of the date first above written.

Virgenes-Triunfo Joint Powers Authority ,  
as Counterparty

DocuSigned by:  
*David W. Pedersen*  
By: \_\_\_\_\_  
Name: David W. Pedersen  
Title: General Manager

SCHEDULE I  
Amendments to Agreement

1. Amendment No. 1 to Solar Power Purchase Agreement by and between Las Virgenes Solar 1, LLC and Las Vigenes-Triunfo Joint Powers Authority, dated September 6, 2019

2. Amendment No. 2 to Solar Power Purchase Agreement by and between Las Virgenes Solar 1, LLC and Las Vigenes-Triunfo Joint Powers Authority, dated December 30, 2019



SCHEDULE II  
Assignments

[SCHEDULE III  
Investor Notice Address

Morgan Stanley Renewables Inc.  
c/o Morgan Stanley  
1585 Broadway, Floor 4  
New York, NY 10036  
Attn: Jorge Iraborri  
Facsimile: 212 507-3547  
Email: Jorge.Iraborri@morganstanley.com

With a copy to:

Morgan Stanley Renewables Inc.  
c/o Morgan Stanley  
1585 Broadway, Floor 4  
New York, NY 10036  
Attn: Darren Ho  
Facsimile: 212-507-4084  
Email: darren.ho@morganstanley.com

Agent Notice Address

Fifth Third Bank, National Association, as Administrative Agent  
201 N. Tryon Street, Suite 1700  
Mail Drop: NFT17A  
Charlotte, North Carolina 28202  
Attention: Portfolio Management  
Email: Natalie.Trojan@53.com; Scott.Summey@53.com

Estoppel Certificate

November 18, 2020

This Estoppel (as amended, amended and restated, supplemented or otherwise modified from time to time, this "Estoppel"), dated as of November 18, 2020, is delivered by Las Virgenes Municipal Water District, (together with its successors, designees and assigns, "Counterparty") to Las Virgenes Solar 1, LLC, a Delaware limited liability company (together with its successors, designees and assigns, "Project Company"), Morgan Stanley Renewables Inc., a Delaware corporation (together with its successors and assigns, "Investor"), and Fifth Third Bank, National Association, in its capacity as administrative agent ("Agent") for the lenders (the "Lenders" and, together with Investor and Agent, collectively, the "Reliance Parties"). Capitalized terms used but not otherwise defined herein shall have the respective meanings ascribed to such terms in the Agreement described below.

RECITALS

WHEREAS, Counterparty and Project Company are parties to the License Agreement, dated as of September 6, 2019 (as amended, modified or supplemented from time to time, the "Agreement") in connection with the approximately 4.008 MW solar electric generation facility being developed by Project Company in Calabasas, CA (the "Facility");

WHEREAS, (i) Investor has agreed to acquire certain membership interests of the direct parent company of Project Company, and (ii) the Lenders have agreed to provide loans to an indirect parent company of Project Company (collectively, the "Investment");

WHEREAS, the Investment is a tax equity and debt transaction relating to the Facility

1. Representations and Warranties and Certain Covenants

(a) Counterparty hereby represents and warrants to Project Company and the Reliance Parties as follows:

(1) The execution, delivery and performance of this Estoppel has been duly authorized by Counterparty.

(2) This Estoppel constitutes the legal, valid and binding obligation of Counterparty, enforceable against it in accordance with its terms, except to the extent limited by bankruptcy, insolvency or other similar laws relating to the rights of creditors, or by general principles of equity.

(3) To the actual knowledge of Counterparty, there are not presently any disputes or any legal proceedings between Counterparty and Project Company relating to the Agreement.

(4) The execution, delivery and performance of the Agreement and this Estoppel by Counterparty, and the consummation of the transactions contemplated thereby and hereby, to the actual knowledge of Counterparty, do not and will not require any further authorizations, consents or approvals or filings with any entity or person which have not been obtained or made, or violate or conflict with any provision of any law, regulation, order, permit, license, rule, judgment, injunction, or similar matters or breach any agreement, any material indenture, contract or organizational document presently in effect with respect to or binding on Counterparty or any properties to which Counterparty may be bound.

(5) All government approvals necessary for the execution, delivery and performance by Counterparty of its obligations under the Agreement have been obtained and are in full force and effect, except those governmental approvals routinely obtained during the ordinary course of business during the execution of the Facility.

(6) To the actual knowledge of Counterparty, there is no litigation, action, suit, proceeding or investigation at law or in equity relating to the Agreement by or before any governmental authority, arbitral tribunal or other body now pending against Counterparty or, to the actual knowledge of Counterparty, threatened against or affecting Counterparty that (i) questions the validity, binding effect or enforceability hereof or of the Agreement against Counterparty, or any action taken or to be taken pursuant hereto or thereto or any transactions contemplated hereby or thereby, (ii) could have a materially adverse effect on the performance of the obligations hereof or of the Agreement by Counterparty or the condition (financial or otherwise), business, or operation of Counterparty; or (iii) could modify or otherwise adversely affect any required approvals, filings or consents which have previously been obtained or made.

(7) Except for the amendments listed in Schedule I herein, the Agreement has not been amended, supplemented or modified since the date of execution of the Agreement.

(8) This Estoppel and the Agreement are the only contracts between Project Company and Counterparty.

(9) Counterparty has not transferred or assigned any interest in the Agreement or, with the exception of the assignments listed in Schedule II herein, received notice of any assignment by Project Company of the Agreement.

(10) To the actual knowledge of Counterparty, neither Party is in default of any of its obligations under the Agreement or has breached any representation, warranty or covenant under the Agreement.

(11) To Counterparty's knowledge, (a) no event of force majeure exists under the Agreement and (b) no event or condition exists which, with the passage of time or the giving of notice or both, would constitute a default or breach by either party or enable either party to terminate or suspend its obligations under the Agreement.

(12) All payments due to or from Project Company under the Agreement through the period ending on the date hereof have been paid.

(b) Counterparty hereby further acknowledges and agrees that:

(1) Project Company, each Reliance Party, and their respective successors and assigns, and their potential equity investors, lenders and participants, and their respective successors and assigns shall be entitled to rely upon this certification by Counterparty.

(2) All milestones and conditions that were required to be completed or satisfied by Project Company under the Agreement prior to the date hereof have been completed or satisfied. Nothing in this subclause (2) will be deemed to be a waiver of the Counterparty's rights under the Agreement.

(3) Counterparty agrees to simultaneously deliver to Investor and Agent, at the addresses provided on Schedule III hereto, a copy of any material notice, including without limitation default or termination notices, delivered to Project Company under the Agreement. Counterparty agrees that no right of Counterparty to terminate or suspend its obligations under the Agreement (a "Termination Event") will become effective under the Agreement unless it provides written notice thereof to Investor and Agent, and neither Investor nor Agent have cured such Termination Event within the same cure period afforded to Project Company under the Agreement. Any curing of or attempt to cure any Termination Event shall not be construed as an assumption by either Investor or Agent of any covenants, agreements or obligations of Project Company under or in respect of the Agreement.

2. Governing Law; Waiver of Jury Trial

THIS ESTOPPEL SHALL BE GOVERNED BY AND CONSTRUED UNDER THE LAWS OF THE STATE OF NEW YORK AND WITHOUT REFERENCE TO CONFLICTS OF LAWS PRINCIPLES.

3. Successors and Assigns

This Estoppel shall be binding upon and inure to the benefit of the Project Company, each Reliance Party and their permitted successors and assigns (which assigns, in the case of any Reliance Party, shall be any nominee or designee of such entity).

[REMAINDER OF PAGE INTENTIONALLY LEFT BLANK]

IN WITNESS WHEREOF, the undersigned has duly executed this Estoppel as of the date first above written.

Las Virgenes Municipal Water District ,  
as Counterparty

DocuSigned by:

*David W. Pedersen*

By: \_\_\_\_\_  
12C6BE2F4EC44E2

Name: David W. Pedersen

Title: General Manager

SCHEDULE I  
Amendments to Agreement

SCHEDULE II  
Assignments



SCHEDULE III  
Investor Notice Address

Morgan Stanley Renewables Inc.  
c/o Morgan Stanley  
1585 Broadway, Floor 4  
New York, NY 10036  
Attn: Jorge Iraborri  
Facsimile: 212 507-3547  
Email: Jorge.Iraborri@morganstanley.com

With a copy to:

Morgan Stanley Renewables Inc.  
c/o Morgan Stanley  
1585 Broadway, Floor 4  
New York, NY 10036  
Attn: Darren Ho  
Facsimile: 212-507-4084  
Email: darren.ho@morganstanley.com

Agent Notice Address

Fifth Third Bank, National Association, as Administrative Agent  
201 N. Tryon Street, Suite 1700  
Mail Drop: NFT17A  
Charlotte, North Carolina 28202  
Attention: Portfolio Management  
Email: Natalie.Trojan@53.com; Scott.Summey@53.com

**INFORMATION ONLY**

December 7, 2020 JPA Board Meeting

TO: JPA Board of Directors

FROM: Facilities & Operations

---

**Subject : Rancho Las Virgenes Composting Facility: Fire Protection for Exterior Amendment Hopper Opening**

---

**SUMMARY:**

The Amendment Building at the Rancho Las Virgenes Composting Facility experienced significant damage during the November 2018 Woolsey Fire. Embers entered the building through the exterior amendment hopper opening, which allowed the fire to spread throughout the eastern portion of the building (see attached photos). Soon after the Woolsey Fire, JPA Director Charles Caspary asked staff to evaluate methods to prevent embers from entering the exterior amendment hopper opening in the future.

Staff evaluated a variety of options and recommends addressing the fire risk associated with the embers entering the exterior amendment hopper opening by covering it with a fire blanket. Fire blankets have successfully been used to cover and smother vehicle fires as shown in the attached photo. These fireproof blankets are large enough to cover the hopper screen and can be weighed down during red flag alerts or an imminent fire threat. The development of a standard operating procedure to deploy a fire blanket would ensure that embers are prevented from entering the hopper.

**FISCAL IMPACT:**

Yes

**ITEM BUDGETED:**

Yes

**FINANCIAL IMPACT:**

Sufficient funding is available in the adopted Fiscal Year 2020-21 JPA Budget for this purpose.

**DISCUSSION:**

The Amendment Building at the Rancho Las Virgenes Composting Facility experienced

significant damage during the November 2018 Woolsey Fire. Damaged facilities in the building included the amendment conveyance system, dust collector and roof structure. The fire entered the building through the exterior amendment hopper located adjacent to the building on the east side.

Trucks deliver the amendment (wood shavings) to Rancho by dumping it adjacent to the exterior hopper screen/grate. The amendment is then pushed into the hopper where it enters the building through a vibrating grate. At the bottom of the hopper, four screw conveyors move the material to another system of conveyors that feed the composting process.

Before the fire got to the composting facility, a load of amendment was delivered and dumped adjacent to the hopper. As the fire moved to the property, the amendment caught fire and embers blew into the hopper. Material in the hopper then caught fire and spread throughout the east side of the Amendment Building. The grating, hopper, screw conveyors, roof structure of the building and bag housing were all damaged by the fire.

Soon after the Woolsey Fire, JPA Director Caspary asked staff to evaluate methods to prevent future fires from damaging the composting facility. Staff included a capital improvement project for fire hardening of JPA facilities in the adopted Fiscal Year 2020-21 JPA Budget, which is intended to evaluate and potentially install advanced fire detectors, fire safety systems and perimeter fire defense systems at key JPA facilities. However, to eliminate the immediate risk posed by the exposed exterior amendment hopper opening, staff proposes a plan to cover the opening with a fire blanket. Fire blankets can be used to cover vehicles and smother a fire. These fireproof blankets are large enough to cover the screen over the hopper. The plan would be to purchase a fire blanket and develop a standard operating procedure to place it over the screen opening. The fire blanket would be deployed and weighed down during red flag alters or an imminent fire threat. It would prevent embers from entering the hopper and keep the facility safe.

Prepared by: Brett Dingman, Water Reclamation Manager

**ATTACHMENTS:**

Photo of Amendment Pile

Photo of Exterior Amendment Hopper Opening

Photo of Fire Blanket







**INFORMATION ONLY**

December 7, 2020 JPA Board Meeting

TO: JPA Board of Directors

FROM: Facilities & Operations

---

**Subject : Pure Water Project Las Virgenes-Triunfo: Energy Demand and Recovery  
for Reverse Osmosis Process**

---

**SUMMARY:**

On October 1, 2020, JPA Director Lee Renger requested that staff provide a report on the energy demand and recovery for the reverse osmosis process as part of the Pure Water Project Las Virgenes-Triunfo. Specifically, Director Renger asked about a comparison of the theoretical and actual energy demand of reverse osmosis process and a description of opportunities or technology to "recapture" energy on the downstream side of the process. Staff contacted Carollo Engineers to provide more detailed information on energy demand and recovery for the reverse osmosis process. The estimated actual energy demand for the process is 1.08 kWh per 1,000 gallons of production (kWh/kgal), which can be compared to a theoretical value of 0.82 kWh/kgal, correlating to an efficiency of approximately 76 percent.

Attached for reference is a report prepared by Carollo Engineers with addition information on the topic, including a high-level analysis of the merits of energy recovery options.

**FISCAL IMPACT:**

No

**ITEM BUDGETED:**

No

Prepared by: Darrell Johnson, Water Systems Manager

**ATTACHMENTS:**

Report by Carollo Engineers on Energy Demand and Recovery for Reverse Osmosis Process



PROJECT MEMORANDUM

# LAS VIRGENES TRIUNFO JPA PURE WATER DEMONSTRATION

Date: 11/16/2020

Project No.: 12161a.00

Client Name

Prepared By: Brandon Yallaly

Reviewed By: Andrew Salveson

Subject: Energy Recovery from RO Systems

## Purpose

Per request from Las Virgenes MWD staff, Carollo was to provide a short summary of energy recovery devices that can be used with reverse osmosis (RO) systems.

## Overview

RO is an energy-intensive process. The energy to drive salt out of water with RO is highly dependent upon the total dissolved solids (TDS) concentration in the feed water to the RO and the type and performance (e.g., fouling) of the membranes in use. Our work in the RO industry indicates that a brackish water RO system (such as a potable reuse project) will use between 1 and 1.5 kWh per 1,000 gallons (kWh/kgal) of production, which can then be adjusted based upon your planned capacity of your future system.

**Based upon our current analysis of your Pure Water Demonstration System (Demo), using a TDS of 990 mg/L and the pressure data for your existing Toray RO membranes, we are estimating 1.08 kWh/kgal. As the pilot develops more data, this energy use projection can be adjusted.**

With an increased focus on energy conservation, many RO users in California are looking for ways to reduce their systems' energy consumption. Energy recovery devices (ERDs) are often used in seawater desalination and have been used by Carollo and the industry in brackish RO applications (e.g., San Diego Pure Water, Chino Concentrate Reduction Facility, WRD Goldsworthy). ERDs have matured to the state where they are attractive options for RO applications like the future full-scale Las Virgenes-Triunfo JPA's Advanced Water Treatment Facility (AWTF). For multistage brackish RO systems, like what is proposed for the JPA's future AWTF, turbine assisted boost pumps (TABP), offered commercially by Fluid Equipment Development Company (FEDCO, USA), are the best technology candidate currently available.

**We estimate that installation of ERDs for your future full-scale project will reduce the energy use by RO from the currently predicted value of 1.08 kWh/kgal to 0.98 kWh/kgal, about a 10% reduction in energy use. The discussion below focuses upon the concepts of the ERD, the energy savings from the ERD, and the payback period for installation and use of ERDs.**



## Turbine Assisted Boost Pumps

A TABP consists of a reaction turbine affixed on a common shaft with a booster pump and variable speed motor as shown in Figure 1. The variable speed motor sits atop the unit with the energy recovery turbine situated between the motor and the booster pump below.

For a future AWTF, turbine assisted booster pumps would be used in place conventional interstage booster pumps on the RO trains. The turbine recovers energy from the high pressure concentrate stream leaving the RO train. In a two-stage system, the variable speed motor would continue to operate much like a conventional interstage booster pump, varying its speed to meet the second-stage RO train permeate flow set point. Figure 2 presents a schematic flow diagram of how a turbine-assisted booster pump would fit into the two-stage system. For a three-stage system, the interstage boost pump would be between stages 2 and 3. The ongoing demonstration testing will determine if a 2-stage or 3-stage RO system will be a better long-term solution for the JPA.

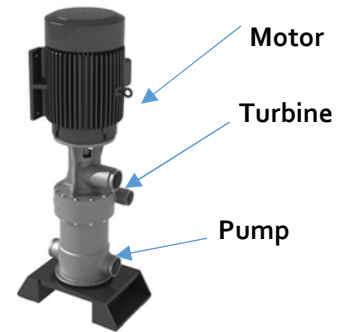

**Figure 1**  
Turbine-Assisted  
Booster Pump

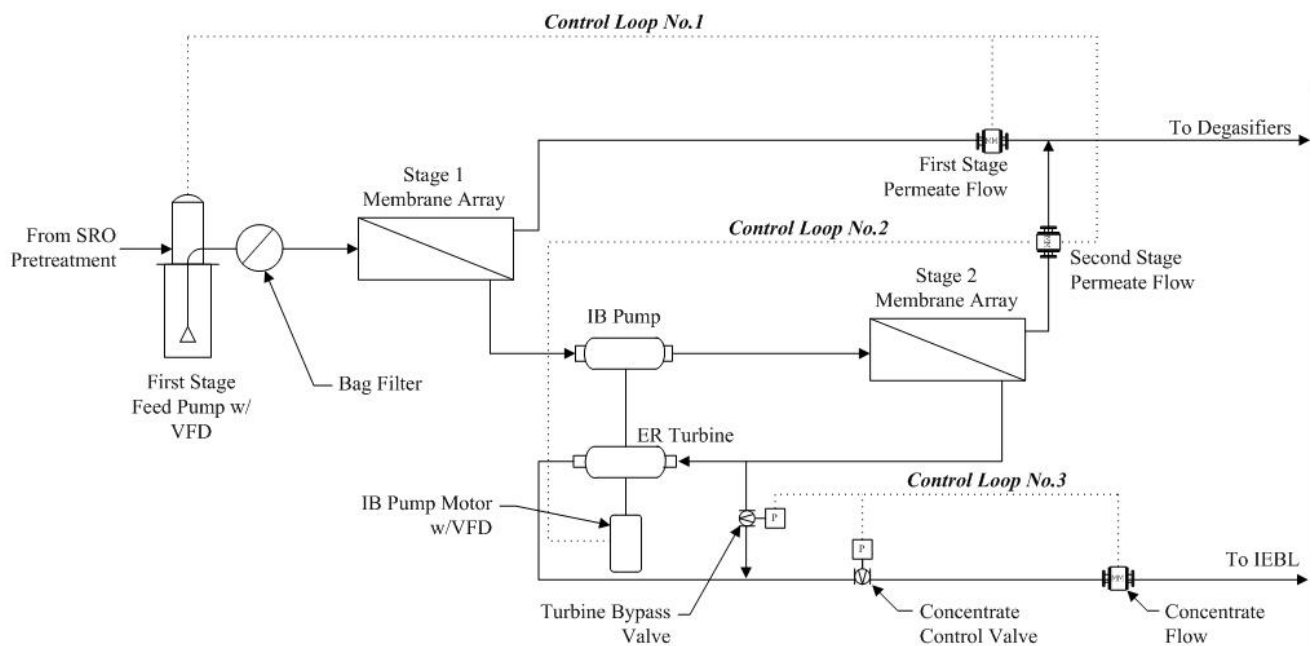

**Figure 2** Two Stage RO Train Flow Schematic (with Turbine-Assisted Booster Pump)

Energy transfer using TARBs for low pressure brackish RO systems is not accomplished with the same efficiency that seawater RO systems are currently operating at. Seawater systems utilize very high efficiency multistage centrifugal or positive displacement pumps, which typically have wire to water efficiency exceeding 90 percent. Likewise, the isobaric work exchanger energy recovery devices developed for single stage RO systems are approaching near perfect energy exchange. Because energy usage is so intense for seawater systems, the higher capital cost of these components is quickly

recovered in energy savings.

While improving, the energy efficiency of TARBs is in the 60 to 80 percent range, and traditional vertical turbine RO feed pumps achieve wire to water efficiency ranging from 70 to 80 percent. Since energy use is considerably lower for brackish reuse applications, the high capital cost of super high efficiency pumps and energy recovery devices results in longer payback periods. Reuse systems must also be able to operate over a much wider range of water quality and recovery rates than seawater systems. As a result of the variable operating conditions and complexity of multistage RO systems, precision engineering of recovery turbines and pumps to achieve efficiency levels similar to seawater RO systems is not currently possible, and the economic driver for research and development in this area has less momentum.

### Energy Recovery Considerations

As the JPA considers whether to provide energy recovery technology at the future AWTF facility, there are several considerations that may factor into a decision, including:

1. **Sustainability improvements:** Less energy used by the RO process means fewer resources are consumed and the production of water will have less impact on the environment. This type of benefit may be valued by the JPA.
2. **Cost reductions:** Because energy is reduced, energy costs will decrease. However, it is important to consider the capital cost of this type of ERDs and how long it may take to realize the benefit of this cost reduction. This capital recovery (payback) period will vary with annual usage of the facility. Fortunately, Southern California Edison (SCE) offers an incentive to their customers that helps to offset capital costs for energy efficiency projects. The JPA may qualify for this incentive program and therefore it should be factored into the capital recovery analysis for implementing energy recovery.

Sustainability and cost reductions are discussed subsequently in this memorandum and are evaluated in terms of annual average usage to help the JPA make an informed decision about the value of utilizing ERDs.

### Sustainability Improvements

Implementing energy recovery at the Las Virgenes AWTF will improve the sustainability of the operations – it would decrease the use of electricity and the associated use of fossil fuels used to make this energy. Because fossil fuel consumption will be reduced, greenhouse gas (GHG) emissions will also be reduced. As presented in Figure 3, depending upon the RO permeate flow, and assuming a recovery rate of 80 percent, energy recovery will result in substantial energy savings. Based upon data provided by SCE, this would result in an annual carbon dioxide emissions reduction of between 16 to 49 tons of CO<sub>2</sub> per year based on a range of 1 to 3 mgd or RO permeate production.<sup>1</sup>

---

1 Emissions factor: 1.00 lbs of CO<sub>2</sub> per kWh of power delivered for CDA's service area. Conversation with Hao Bui, SCE field engineer (March, 2011).

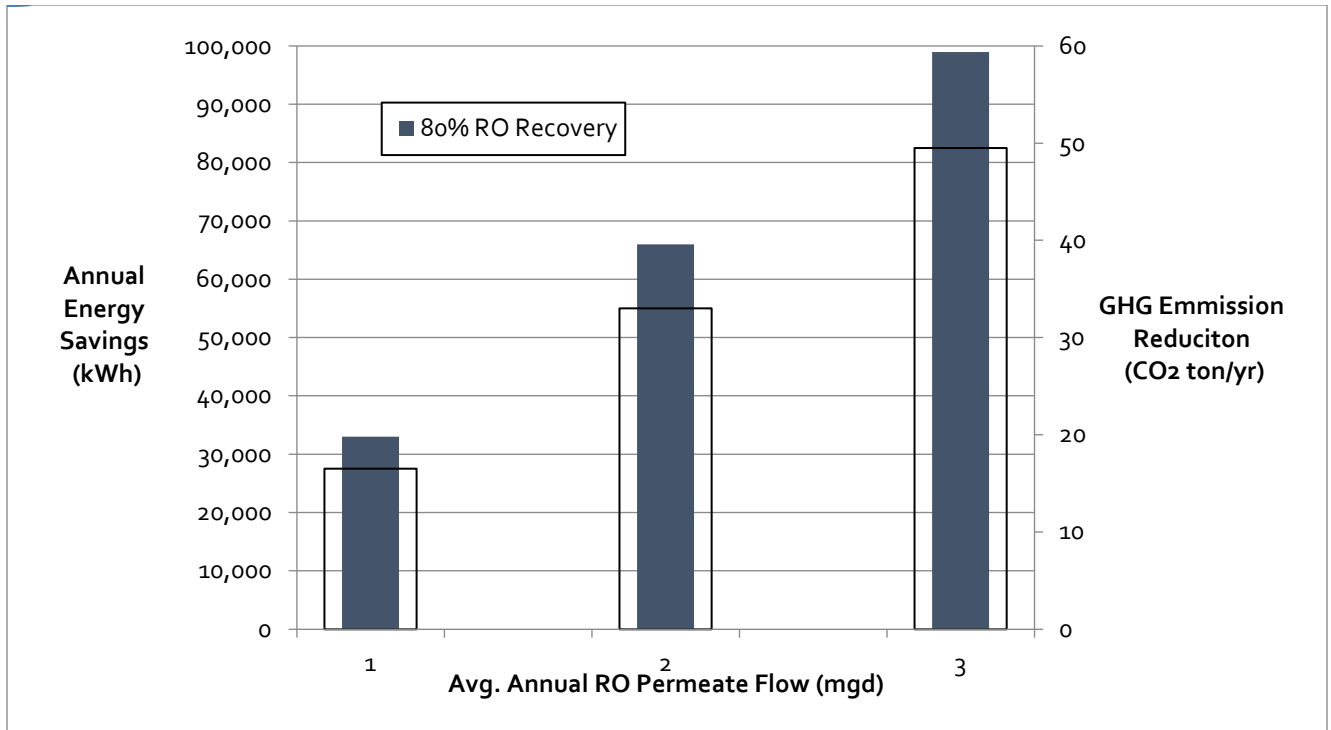

**Figure 3 Sustainability Benefit of Energy Recovery**

### Cost Analysis

Capital costs must be weighed with the annual savings associated with implementing an energy recovery project at the future full-scale AWTF. It is important to consider how long it may take to realize the benefit of the annual costs savings once the initial capital costs have been recovered. The cost analysis presented herein is based on a range of permeate flows from 1 to 3-mgd, which could be adjusted depending upon the future planned annual production of purified water. The capital cost assumes three 1-mgd trains, and therefore, the capital cost is the same, and the payback period is based on the amount of utilization.

Capital costs for implementing energy recovery at the Las Virgenes AWTF consists of the following elements:

- Installation of turbine-assisted booster pumps with associated piping and controls as part of the RO trains.
- PLC programming.

For the purposed of this analysis, the capital cost presented is the difference in cost between installing a traditional interstage boost pump and the use of an TARB. The estimated cost difference of \$37,000 per train

### Payback Analysis

In addition to the benefits associated with reducing carbon dioxide emissions and improving sustainability, the JPA should consider the years of operation required before the savings associated with energy recovery have resulted in an annual savings. Figure 4 presents this analysis as a function of annual average RO permeate flow rate and recovery.

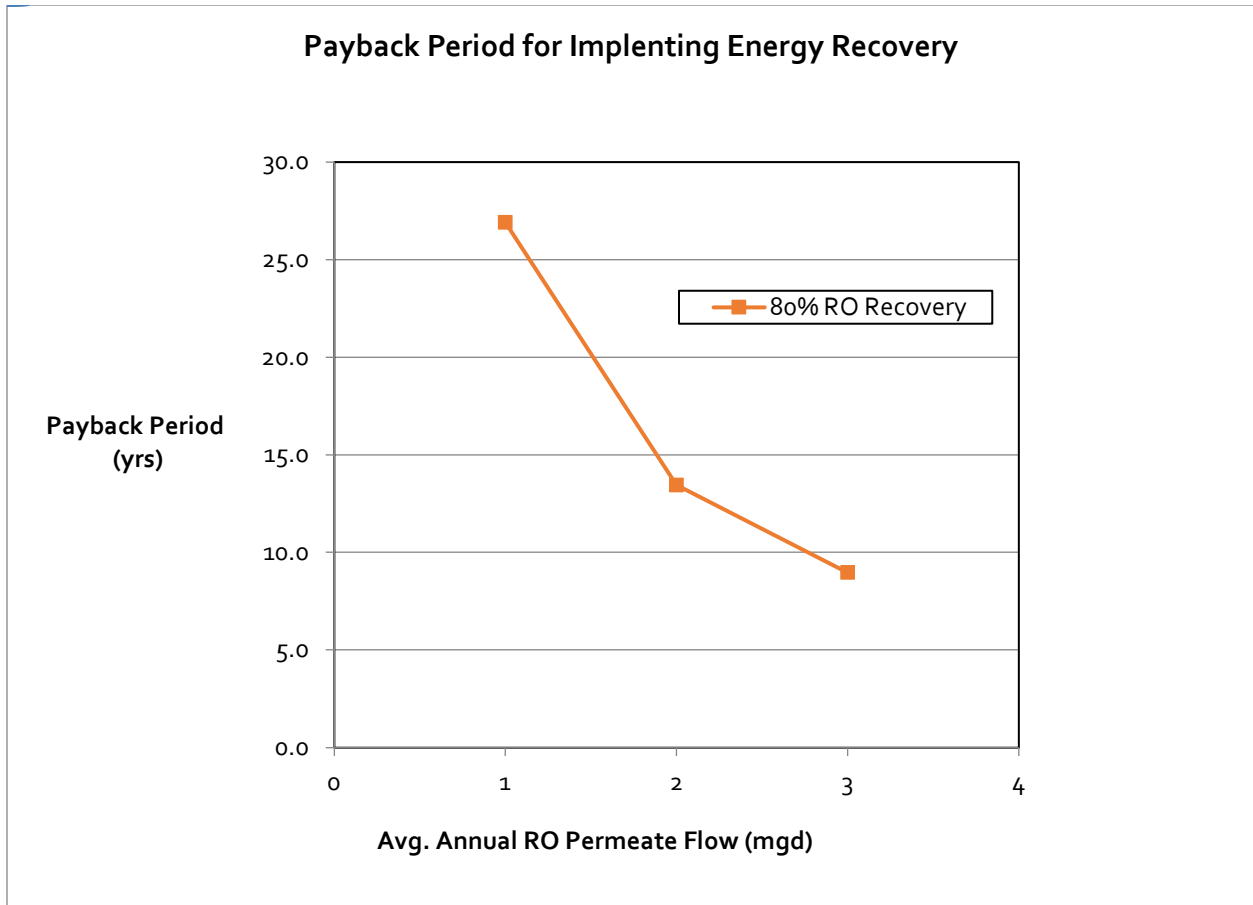

**Figure 4 Payback Period for ERD**

### Summary

Many utilities that use RO in California and across the United States are looking at the possibility of implementing energy recovery to improve sustainability and reduce operating costs. For the JPA, costs and benefits will vary based upon the annual average RO permeate flow rate at the AWTF. At an RO permeate flow rate of 3 mgd, the following costs and benefits would be expected:

- **Capital Cost (Estimated):** Less than \$125,000
- **Annual Savings:** \$4,000 to \$12,000 per year depending upon production.
- **Simple Payback Period:** 9 to 27 yrs depending upon production.
- **Annual GHG Emission Reduction:** 16 to 49 tons of CO<sub>2</sub> per year, depending upon production.